



EMC filters

For a reliable power supply
and MCR circuits

EMC filters

for a reliable power supply

Filters limit high-frequency interference voltages and currents generated by equipment during normal operation and occurring under fault conditions. Using our EMC filters, you ensure smooth operation in environments subject to interference.

Slim design

Ideal for protecting MCR applications



Comprehensive portfolio

- International and application-specific approvals
- Universal use in power supply systems (TN, TT, IT)

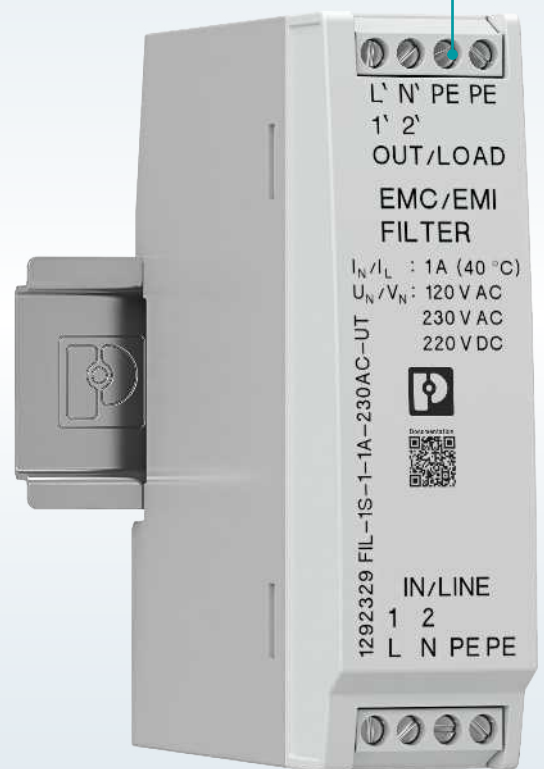

Simple and flexible installation

Product versions with Push-in and screw connection

The new standard for the control cabinet. More information on pages 10 to 11.

EMC-optimized installation

Additional PE terminals for separate connection to local equipotential bonding

Remote indicator connection

EMC-optimized metal housing

Surge protection status indicator

Double protection

Powerful surge protection on the input and output side of the filter

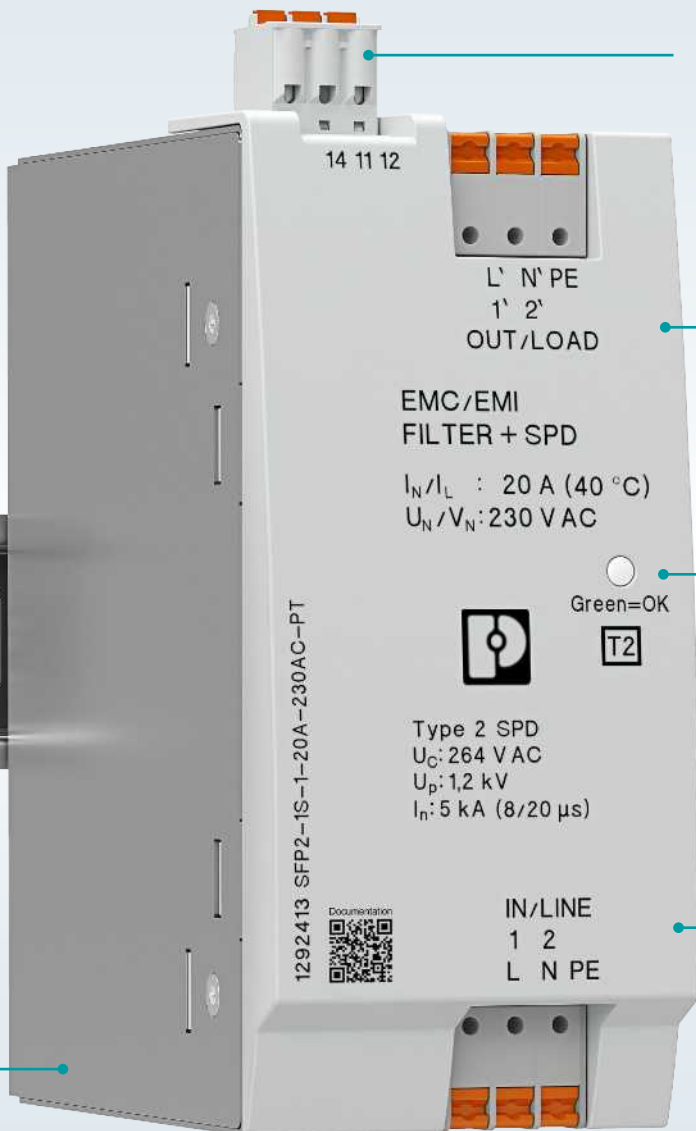

Reliable system operation in environments where interference is an issue

Sources of interference and its effects



Conducted interference

Energy efficiency plays an important role in modern electrical systems. Power electronics equipment is increasingly being used to achieve a high level of energy efficiency. Power electronics equipment (e.g., switched-mode power supply units, frequency converters) usually contains switched electronic components. High energy efficiency is achieved due to the high switching frequencies of the electronic components.

In energy technology equipment, high switching frequencies have advantages, but they also often result in the increased generation of high-frequency conducted interference. Power electronics equipment does not just consume electricity. It is usually also a source of high-frequency conducted interference.

Conducted interference is distributed via power cables in the power supply system and can result in malfunctions on sensitive equipment. The conducted interference generated by a single item of power electronics equipment does not usually negatively impact other equipment.

In power supply systems, many items of power electronics equipment are often used together at the same time. The resulting high-frequency conducted interference that is generated quickly mounts up. The extent of this interference can be so great that other items of sensitive equipment can

suffer temporary or permanent malfunctions. In this context, the problem is one of electromagnetic compatibility (EMC).

EMC filters help against conducted interference

In real-life electrical systems, it is often not possible to replace equipment that causes interference with less disruptive equipment. Nevertheless, it is possible to ensure the satisfactory operation of sensitive equipment by using EMC filters.

In power supply systems, EMC filters help reduce high-frequency conducted interference. This allows sensitive equipment to be operated without malfunctions.

FIL-1S-1 type EMC filters (up to 230 V AC, up to 220 V DC, 1 ... 20 A) are used to protect sensitive single-phase equipment against high-frequency conducted interference.

SFP2-1S-1 type EMC filters (120 V AC, 230 V AC, 5 ... 20 A) are additionally equipped with an integrated surge protective device (SPD). These mains filters are used when sensitive single-phase equipment also needs to be protected against man-made or lightning-related surge voltage or surge current pulses.

Protection of MCR circuits

High-frequency conducted interference does not just occur in power supply systems, it also occurs in MCR circuits. For example, this interference can be coupled into MCR circuits galvanically, inductively, or capacitively. These days, high-frequency interference is a common cause of malfunctions in MCR systems. MCR circuits, with a voltage up to 24 V, can be protected effectively by using TTC-6-SFP type EMC filters. These EMC filters also have an integrated surge protective device (SPD).

Typical applications for EMC filters

Interference from frequency converters

Robots are used in many industrial applications and their drive motors are controlled by frequency converters. The high-frequency interference generated by frequency converters can influence sensitive equipment. For example, this may include programmable logic controllers, operation and monitoring devices, and

other automation technology equipment. FIL-1S-1 type mains filters are used to protect against high-frequency conducted interference on power supply cables. Due to the parallel installation of energy technology cables with MCR circuits, high-frequency interference can be coupled into MCR circuits. TTC-6-SFP type EMC filters are

used to protect MCR circuits against high-frequency interference.

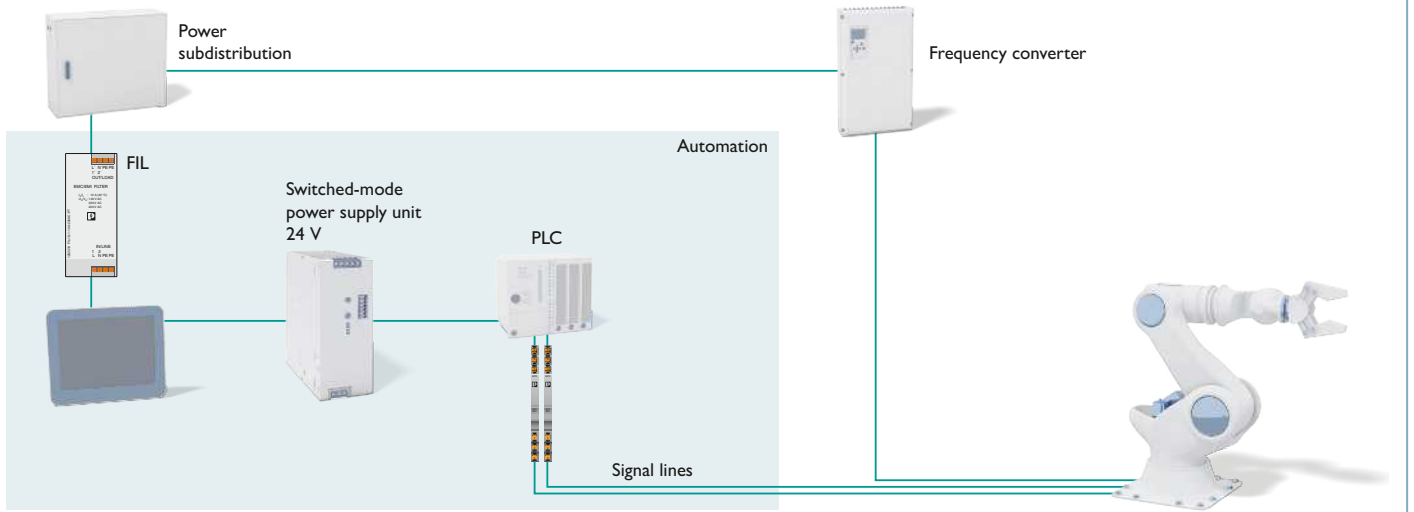

Interference from LED drivers

These days, LEDs are used in a variety of ways in energy-efficient lighting systems. LEDs always require an LED driver. Depending on their technical design, LED drivers can be a major source of high-frequency conducted interference. The interference generated by LED drivers can result in malfunctions on sensitive

equipment such as automation technology equipment. FIL-1S-1 type EMC filters are used to protect against high-frequency conducted interference on power supply cables.

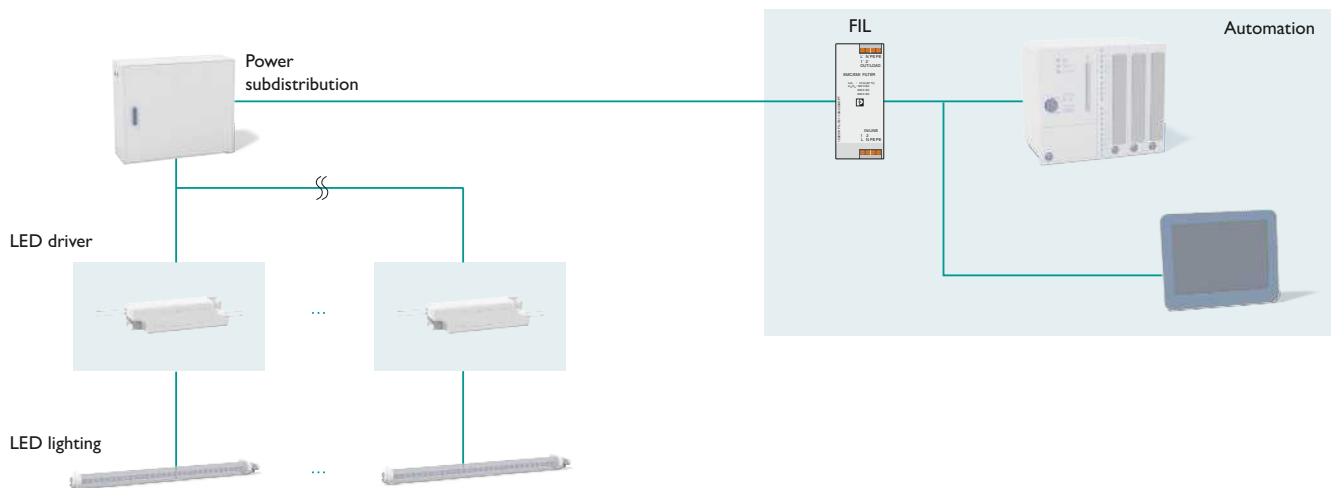

EMC filters with surge protection for reliable operation in your systems

SFP2 ... are EMC filters with integrated surge protection in metal housing for an improved filter effect and EMC-optimized installation. They provide protection against high-frequency interference and transient overvoltages on the input and output side of the filter.







Product overview

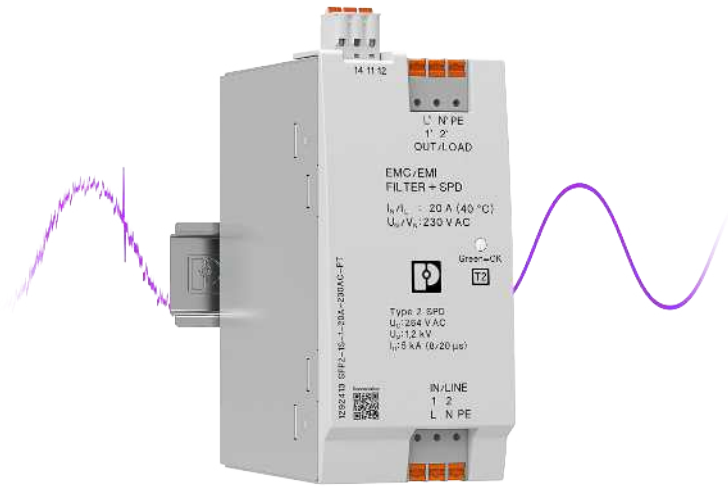

Double protection

Conventional filters only protect against high-frequency interference, but not against overvoltage pulses. For effective protection, additional surge protection components are needed. SFP2 filters provide effective protection against surge voltages and high-frequency interference as they feature a surge protection circuit that protects both the input and output side of the filter.



EMC filters with surge protection

				
Nominal load current	5 A	10 A	15 A	20 A
Type	SFP2-1-5A-120AC	SFP2-1-10A-120AC	SFP2-1-15A-120AC	SFP2-1-20A-120AC
Item number for Push-in	1292458	1292455	1292450	1292419
Item number for screw	1292315	1292457	1292453	1292421

			
Nominal load current	6 A	10 A	20 A
Type	SFP2-1-6A-230AC	SFP2-1-10A-230AC	SFP2-1-20A-230AC
Item number for Push-in	1292417	1292414	1292413
Item number for screw	1292418	1292416	1292605

EMC filters provide an improved filter effect for high-frequency interference

Thanks to the additional PE terminals for the separate connection to the local protective bonding, the FIL... EMC filters provide an improved filter effect against the ground potential. This means that a good level of protection against high-frequency interference can be achieved even with filters in plastic housing.



Simple and flexible installation

Thanks to the simple DIN rail mounting and the variable connection technology, using the filters in the control cabinet is child's play. To connect the interference suppression filters, you can choose between fast Push-in connection technology or proven screw connection.





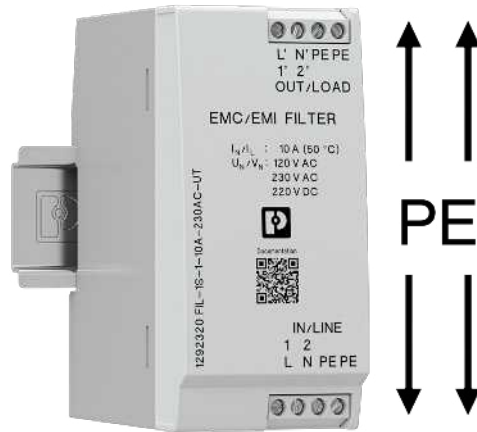

Product overview

EMC-optimized installation

The connection of the interference suppression filters to the local protective bonding is realized by additional PE terminal points. This improves the filter effect for high-frequency interference between the active conductors and the ground potential. This way, an EMC-optimized installation and an improved protective effect is also achieved for EMC filters in plastic housings.



EMC filters

					
Nominal load current	1 A	3 A	6 A	10 A	20 A
Type	FIL-1S-1-1A-230AC	FIL-1S-1-3A-230AC	FIL-1S-1-6A-230AC	FIL-1S-1-10A-230AC	FIL-1S-1-20A-230AC
Item number for Push-in	1292328	1292326	1292321	1292319	1292316
Item number for screw	1292329	1292327	1292323	1292320	1292318

EMC filters with integrated surge protection for applications in MCR technology

With an overall width of just 6 mm, the filters in the TERMITRAB complete family provide the ideal protection against high-frequency interference for applications in measurement and control technology. Thanks to the integrated surge protection circuit, the narrow filters enable additional fine protection against transient overvoltages.

TTC-6-SFP-24AC-PT
Item number [1316312](#)



COMPLETE line – the comprehensive solution for the control cabinet

The COMPLETE line system encompasses technologically leading and coordinated hardware and software products, consulting services, and system solutions that help you optimize your processes in control cabinet manufacturing. Engineering, purchasing, installation, and operation become significantly easier for you.

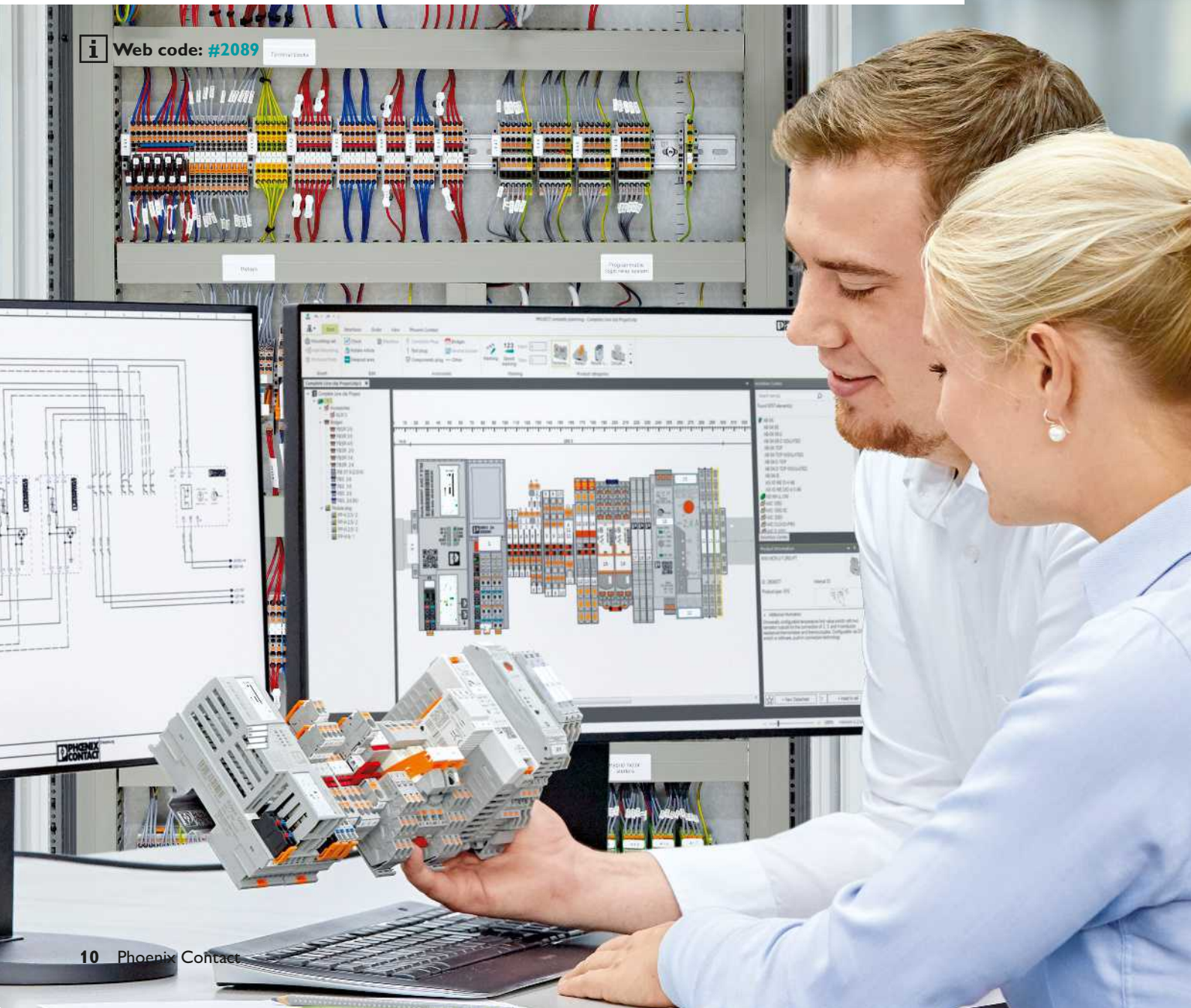

Your advantages in detail:



Comprehensive product portfolio

With COMPLETE line, we offer a complete product portfolio of technologically leading products. This includes the following:

- Controllers and I/O modules
- Power supplies and device circuit breakers
- Terminal blocks and distribution blocks
- Relay modules and motor starters
- Signal conditioners
- Safety technology
- Surge protection
- Heavy-duty connectors



Intuitive handling

Thanks to the simple, intuitive handling of the coordinated hardware components, you will save time during installation, startup, and maintenance. With Push-in connection technology, you can wire applications quickly and without using tools. The broad, technologically leading product portfolio will always provide you with the right product for standard or special applications.



Save time throughout the entire engineering process

The clipx ENGINEER planning and marking software supports the entire process of control cabinet manufacturing. The program features an intuitive user interface that allows the individual planning, automatic checking, and direct ordering of terminal strips.



Reduced logistics costs

Reduced variety of parts with standardized marking, bridging, and testing accessories. The COMPLETE line system coordinates products, design, and accessories so that you benefit from maximum reusability and thus reduce your logistics costs.



Optimized processes in control cabinet manufacturing

COMPLETE line supports you, from engineering through to manufacturing, in designing your control cabinet production as efficient as possible. This is how your customized concept for optimizing your processes in control cabinet manufacturing is created. Our terminal strip production helps you to flexibly manage order peaks or to supply your control cabinet production with fully assembled DIN rails just in time.



The new standard for the control cabinet

Discover the extensive COMPLETE line product portfolio and find out more about COMPLETE line and your comprehensive solutions for the control cabinet.

Visit our website:
phoenixcontact.com/completeline

Open communication with customers and partners worldwide

Phoenix Contact is a global market leader based in Germany. We are known for producing forward-thinking products and solutions for the comprehensive electrification, networking, and automation of all sectors of the economy and infrastructure. With a global network, we maintain close relationships with our customers, something we believe is essential for our common success.

You can find your local partner at
phoenixcontact.com

