



# 2023 HEAVYCON heavy-duty connectors

Compatibility for today, technology for tomorrow

# The right connector for every application with HEAVYCON

Heavy-duty connectors from the HEAVYCON series protect your connections and ensure secure power, data, and signal transmission even under the harshest conditions. Resistant to dirt, water, vibrations, and high mechanical stresses, connections remain secure with UL Type 4X and an IP69 degree of protection. You will always have the right plug-in connection for your requirements with housings from our various series types with convenient matching contact inserts.

## Space-saving series

### D7 series

The D7 series offers the most compact format for heavy-duty interconnect. At the same time, it accommodates signal, data, and power transmissions.

- Smallest footprint
- Up to 40A per pin
- Includes Cat6 RJ45 solutions
- Available in salt water-resistant aluminum or plastic housings

### EVO M1 (Modular 1)

The plastic M1 single module housings accommodate a modular contact insert and a PE module, thus enabling extremely compact interfaces.

- A cost-effective method for protecting single modules
- Can utilize nearly all single-slot modules
- Separate PE terminals available for grounding

### HEAVYCON COM (Compact)

This series' space-saving design is compatible with other compact rectangular connectors on the market today. It offers a unique grounding method by tying the center PE pin to the mounting screws, eliminating the need for a secondary grounding connection inside the housing.

- Salt water-resistant aluminum
- Plastic housings with integrated cable glands
- Crimp, PT, and axial screw terminations
- Connects with M12 Power distribution boxes

### D15/D25 series

EVO housings in sizes D15 and D25 are very narrow and protect your interfaces even when space is limited.

- Slim design for tight installations
- Salt water-resistant aluminum housings
- Plastic EVO housings



## PXR What is it?

Phoenix Contact eXtended Reality

### Using PXR

Scan QR codes located throughout this document with your mobile device camera or QR code reader to launch PXR.

Interact with the 3D model of the product. Click the 'Website' button to see listings, or 'View in my space' to project the model into your area (AR experience).

**Scan the above QR code to get started!**



## Standard B series

### HEAVYCON STA (Standard)

The STANDARD series features a wide range of robust metal housings with various cable outlet directions and locking mechanisms.

- High corrosion resistance
- Flexible single- or double-locking latches
- Mounting and plug-in compatible
- IP66/IP67

### HEAVYCON EVO (Evolution)

The bayonet lock of the EVO series enables you to adjust the cable outlet direction flexibly on-site.

- Free selection of cable outlet direction
- Lower logistics costs
- Flexible single- or double-locking latches
- Mounting and plug-in compatible

### HEAVYCON ADV (Advance)

ADVANCE housings are particularly robust and durable, due to the direct screw-locking mechanism without a panel mounting base.

- High degree of protection ideal for increased environmental requirements
- Cost advantage with direct mounting
- Mounting compatible
- IP68/IP69



## Contents

HeavyCORE initiative	4
<hr/>	
HEAVYCON highlights	
Modular contact inserts	6
HEAVYCON EVO	8
Online 3D configurator	10
<hr/>	
Product listings	
Contact inserts for D7 housings	12
STANDARD D7 housings	13
COMPACT series inserts and housings	14
EVO M1 series	15
Contact inserts for D15, D25, D50 housings	16
STANDARD and EVO housings D15, D25, D50	17
Modular contact inserts for B housings and EVO M1	18
Contact inserts with a fixed number of positions for B housings	20
Crimp contacts	22
Punch-rolled crimp contacts	23
EVO B plastic housings	24
Single-latch EVO and STANDARD B metal housings	26
Double-latch EVO and STANDARD B metal housings	28
Reverse double-latch EVO and STANDARD B metal housings	29
ADVANCE B housings	30
HPR B housings	31
Cable glands and adapters, plastic	32
Cable glands and adapters, metal	34
Cable glands and adapters for NPT threads	36
Protective covers	37
Connector kits	38
<hr/>	
Additional information	40
<hr/>	
Solution Center value-add services	41
<hr/>	
The Cabinet Confidence Limited Lifetime Warranty	42
<hr/>	

# HeavyCORE initiative

Under HEAVYCON, there are thousands of components that can be combined in over 70 billion different combinations. That being said, many requirements can be satisfied with a select set of those components. That's where HeavyCORE comes in.

HeavyCORE is a new program focusing on the products that yield the most “bang for your buck” to increase your efficiency and productivity.

Throughout this brochure, several items will be highlighted as HeavyCORE program items. Utilizing these components to fulfill your design needs provides the following:

- ✓ Best stock position and availability
- ✓ Puts Phoenix Contact technology to work for you
  - Boosts productivity
  - Reduces inventory liability
  - Allows for additional versatility during assembly and installation
- ✓ Provides an avenue to support more traditional designs

Where to find HeavyCORE online:

- i** **Web code: #2689** Contact inserts and contacts
- i** **Web code: #2690** Housings
- i** **Web code: #2691** Cable glands and adapters

## Pushing beyond...

While compatible with other manufacturer's standard rectangular connectors, Phoenix Contact offers technological advantages others simply cannot match.

- Snap-in modular insert frames
- EVO bayonet locking system for glands and adapters
- Das Original PT wire terminations
- High-grade aluminum housings that eliminate the need for powder coatings
- Compact mounting screw with PE grounding
- Cost-effective single modular insert housings – EVO M1
- ADV housings for reduced cost, tool disconnect, and enhanced sealing properties



### Switch to HEAVYCON EVO

Save on material and storage costs. The flexibly mounted cable gland with bayonet lock replaces up to eight types of STA standard housings. The EVO gland can accommodate either top or side entry at the time of installation.

## Where to find

Look for the highlighted items throughout the brochure

### Panel mounting bases with single-locking latch

	Without cover		1411318	1411320	1411324	1411329	1424863		1411318	1411320	1411324	1411329	1424863
	With cover		1411319	1411321	1411325	1411330	1424864		1411319	1411321	1411325	1411330	1424864

### Surface mounting housings with single-locking latch

	Low, without cover	M20	1412821	1412839				Pg16	1412823	1412842			
		M25	1412822	1412840	1412861	1412877		Pg21	1412824	1412843	1412863	1412879	
		M32			1412862	1412878		Pg29					
		M40						Pg36					
	High*, without cover	M25	1082556	1082578	1082586								
		M32	1082559	1082579	1082587	1082592	1424867	Pg29					1424865
		M40	1082566	1082580	1082588	1082593	1424868	Pg36					1424866
	Low, with cover	M20	1412825	1412844				Pg16	1412827	1412846			
M25		1412826	1412845	1412865	1412881		Pg21			1412867	1412883		

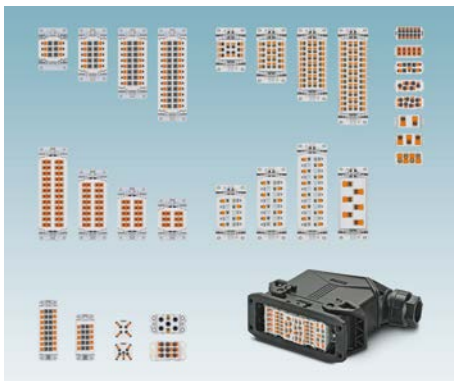

### User-friendly push-in connection

Contact inserts with push-in connection provide easy wiring with quick connection time and a secure connection.



### Simply snap into place

Mount any module combination quickly and easily with the innovative snap-in frame. Snap the contact inserts into place and the job is done. Springs on the side accommodate the modules and hold them securely in position.



### Quality in every application

A process-oriented, integrated management system ensures that legislation and standards as well as customer requirements are taken into account during the manufacturing of our products.



# Modular contact inserts – everything in one housing

With HEAVYCON modular, you can create your own individual connector. By combining a wide range of transmission media in one housing, you can easily create a modular and highly compact interface. The broad product range is comprised of contact inserts for power, signal, and data transmission, as well as for pneumatic applications.

The innovative snap-in frame with sturdy catch springs enables quick mounting, and it fits into all HEAVYCON B series housings.

**i** Web code: #0516



## For all applications

We provide modules for currents of up to 200 A, voltages of up to 2,500 V, signal transmission up to 25 pos., secure data transmission, and inserts for pneumatic applications.



## Simply snap into place

Mount any module combination quickly and easily with the innovative snap-in frame. Snap the contact inserts in and the job is done. Springs on the side accommodate the modules and hold them securely in position.



## Easy wiring

Achieve fast contact termination without tools using contact inserts with push-in connection that provide a convenient conductor connection resistant to vibrations.

## Push-in Technology<sup>®</sup>

Designed by PHOENIX CONTACT

Know that you have the right connector for every application with our comprehensive range of contact inserts, complete with modules and frames compatible with the market standard.



### Data transmission via RJ45

Easily integrate RJ45 data cables into your application with the RJ45 modules. We also offer pre-assembled patch cables that are ready for installation.



### Flexible, even in tight installation spaces

The plastic M1 single-module housings accommodate a modular contact insert and a PE module, thus enabling extremely compact interfaces.



### For high packing density

We provide push-in inserts with a compact terminal chamber for high-position applications and modules that allow two wires per terminal for daisy chaining.

# HEAVYCON EVO – ingenious flexibility

Switch to HEAVYCON EVO now and save on material and storage costs. The flexibly mounted cable gland with bayonet lock replaces up to eight types of STA standard housings. With the angled outlet, both outlet directions can be conveniently used.

The EVO housings are secure and reliable, with shock-proofing up to IK09 and qualifications to satisfy the requirements of the IP66/IP67 degrees of protection.

**i** Web code: #0518



## Flexible, even in tight installation spaces

The plastic M1 single-module housings accommodate a modular contact insert and a PE module, thus enabling extremely compact interfaces.



## For conditions with limited space

EVO housings in sizes D15 and D25 are very narrow and protect your interfaces even when space is limited.



## Two flexible cable outlets

The EVO TWIN housings have two flexible cable outlets on one plastic housing, providing space for a wide variety of cables.





### Flexible connection in minutes

The cable gland is separate from the housing, and is securely locked into place in just a few minutes using the bayonet lock, so there is no need for special tools.



### Two outlet directions

With the flexible bayonet locking, you can determine the cable outlet direction on-site and subsequently change it, if required. Choose from either a straight or side outlet.



### Reduced number of versions

HEAVYCON EVO housings reduce the number of versions, and therefore your warehousing costs, by up to 70%. Using just one housing type and four cable glands, you can implement solutions for every possible application.



### Fully compatible

The sleeve housing and base housing are mounting and plug-in compatible with aluminum housings from well-known manufacturers. All contact inserts in the B series format can be used in the housings.

# Configure and order heavy-duty connectors online

The new HEAVYCON online configurator provides you with ideal support for designing your tailor-made connector. Select from countless possible combinations. The configurator will only recommend parts suitable for the selected components.

With simple filter menus, 2D and 3D product images, as well as an intuitive user interface, you can configure your connectors in just a few steps – without errors. Add your solution to the shopping cart and download your bill of material immediately.



## Your advantages

- ✓ Convenient configuration with just a few entries
- ✓ Intuitive operation with drag-and-drop
- ✓ Custom combination in accordance with your specific requirements
- ✓ User-friendly visualization with real-time 3D representation of your configuration
- ✓ Easy planning with 2D or 3D data that you can import into your CAD software

# Online configurator for heavy-duty connectors

## Images simplify selection

Simply drag the components to the desired position using the drag-and-drop function, and the configurator automatically updates the preview.

For quick access to the configurator for heavy-duty connectors, simply enter the web code into the search field on our website.

**i** Web code: #3

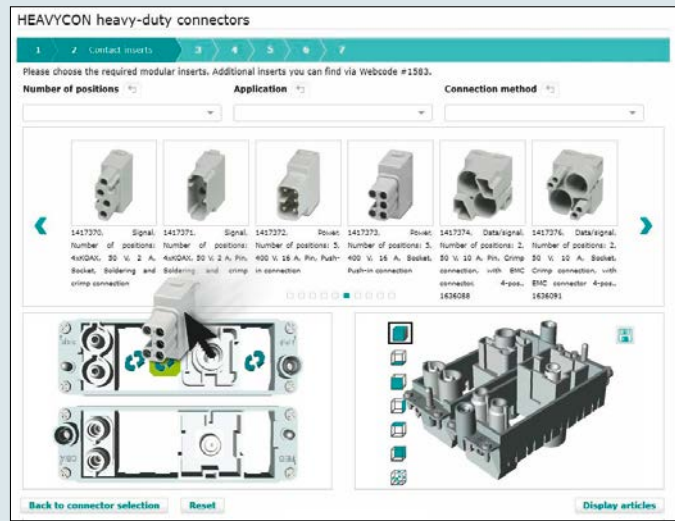

## Your desired connector in just a few steps

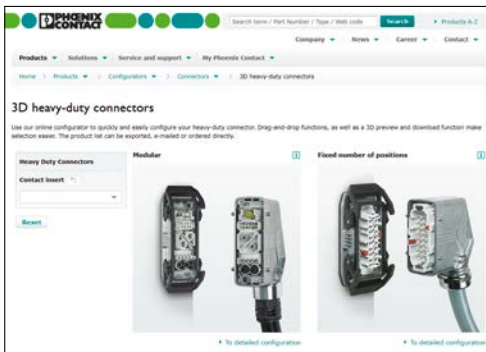

### 1. Select connector type

HEAVYCON complete features housings, contact inserts with a fixed number of positions, and modular contact inserts for all applications.



### 2. Combine inserts with a housing

Select the appropriate contact inserts for the transmission of data, signals, power, or pneumatic applications in accordance with your requirements. Then specify the housing and gland.

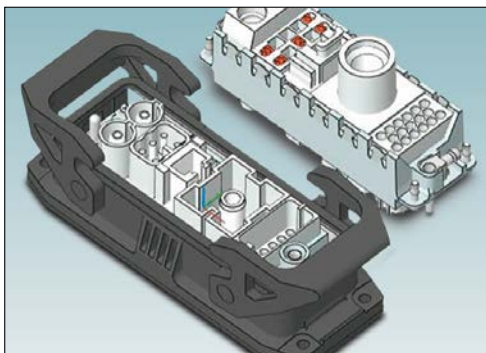

### 3. Download the CAD data

Integrate the fully configured solution into your CAD system.

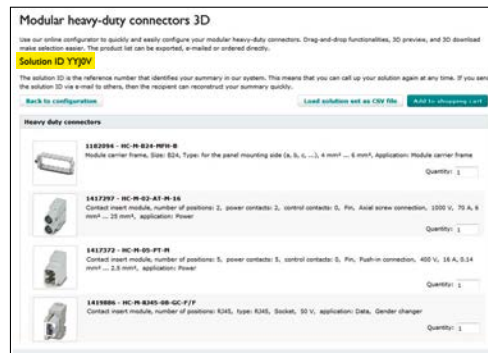

### 4. Download the configuration

The product list can be exported, processed further, or added to the cart. Most importantly, you can call up the configuration at any time by entering the solution ID into our website search field.





# Contact inserts for D7 housings

**i** Web code: #0586

	Connection	Connection cross-section IEC // UL	Rated current IEC // UL	Rated voltage IEC // UL	Version	Number of positions	
A series						3	4
	Push-in (PT)	0.14 mm <sup>2</sup> ... 1.5 mm <sup>2</sup> AWG 16	10 A // 17.5 A	230/400 V // 600 V	Female	1585265	1585281
					Male	1585252	1585278
	Screw (UT)	0.14 mm <sup>2</sup> ... 2.5 mm <sup>2</sup> AWG 14	10 A // 24 A	230/400 V // 600 V	Female	1585223	1585249
					Male	1585210	1585236
D series						7	8
	Crimp CK 1,6 (CT)	0.14 mm <sup>2</sup> ... 2.5 mm <sup>2</sup> AWG 14	10 A // 12 A	50 V // 600 V	Female		1584363
					Male		1584350
	Crimp CK 1,6 (CT)	0.14 mm <sup>2</sup> ... 2.5 mm <sup>2</sup> AWG 14	10 A // 12 A	250 V // 600 V	Female	1584347*	
					Male	1584334*	
Q series						2	3
	Crimp CK 4,0 (CT)	1.5 mm <sup>2</sup> ... 6.0 mm <sup>2</sup> AWG 10	40 A // 50 A	400 V // 600 V	Female	1419895	1419897
					Male	1419893	1419896
						4	
	Crimp CK 4,0 (CT)	1.5 mm <sup>2</sup> ... 6.0 mm <sup>2</sup> AWG 10	40 A // 50 A	830 V // 600 V	Female	1419899*	
					Male	1419898*	
						5	
	Crimp CK 2,5 (CT)	0.5 mm <sup>2</sup> ... 2.5 mm <sup>2</sup> AWG 14	20 A // 24 A	230/400 V // 600 V	Female	1406537	
					Male	1406538	
						7	
	Crimp CK 1,6 (CT)	0.14 mm <sup>2</sup> ... 2.5 mm <sup>2</sup> AWG 14	12 A // 17.5 A	400 V // 600 V	Female	1418623	
					Male	1418624	
						12	
	Crimp CK 1,6 (CT)	0.14 mm <sup>2</sup> ... 2.5 mm <sup>2</sup> AWG 14	12 A // 15 A	400 V // 600 V	Female	1418625	
					Male	1418626	
						<b>RJ45</b>	
	RJ45 gender changer		CAT6 <sub>A</sub>		Female	1422590	
	RJ45 male insert		CAT6 <sub>A</sub>		Male	1077117	
	RJ45 adapter		For RJ45 patch cables		Male	1077120	Compatible patch cables listed in 1077120's "Accessories" tab on website
	RJ45 adapter		For RJ industrial inserts		Male	1077119	

\* Only suitable for plastic housings.  
For crimp contacts, see pages 22-23.

Denotes **HeavyCORE** stock designation product

	Version		Plastic (IP66)		Metal (IP66/67)			HPR (IP68/69K)	
			M20	M25	M20	M25	Pg11	M20	M25
<b>Sleeve housings</b>									
	Straight		1419255	1419256	1419229	1419231	1419232	1424638	1424639
	Side		1419257	1419258	1419235	1419236	1419237		
<b>Panel mounting bases, straight</b>									
	Without cover		1419265		1419249			1424637	
	With cover	For male inserts	1419278		1419250				
		For female inserts	1419277		1419251				
<b>Panel mounting bases, angled</b>									
			1419266		1419252			1424635	
<b>Surface mounting housings</b>									
	With open bottom		1419267		1419253		1419233		
	With closed bottom		1419268		1419234		1419241	1424641	
<b>Coupling housings</b>									
	Without cover		1419259	1419260	1419238	1419239	1419240		
	With cover	For male inserts	1419263	1419264	1419246	1419247	1419248		
		For female inserts	1419261	1419262	1419243	1419244	1419245		
<b>Feed-through headers, for mounting connector system to machine structure</b>									
			1419269		1419242				
<b>Covers for sleeve housings</b>									
		For male inserts	1419275						
		For female inserts	1419274						
<b>Covers for panel mounting bases, surface mounting housings, and coupling housings</b>									
		For male inserts	1419271					1424636	
		For female inserts	1419270					1424636	

For suitable cable glands, see page 32 onwards.

 Denotes **HeavyCORE** stock designation product











# Contact inserts for COMPACT series housings

**i** Web code: #2158

	Connection	Connection cross-section power // signal	Rated current power // signal	Rated voltage power // signal	Version	Number of pos.	
						4/2	8
<b>Compact series</b>							
	Axial screw (A)	0.5 mm <sup>2</sup> ... 6 mm <sup>2</sup> // 0.34 mm <sup>2</sup> ... 1.5 mm <sup>2</sup> AWG 10 // AWG 16	40 A // 10 A	400/690 V//250 V	Female	1079557	
					Male	1079558	
	Crimp CK 1 (CT)	0.5 mm <sup>2</sup> ... 6 mm <sup>2</sup> // 0.34 mm <sup>2</sup> ... 1.5 mm <sup>2</sup> AWG 10 // AWG 16	40 A // 10 A	400/690 V//250 V	Female	1079556	
					Male	1079555	
	Push-in (PT)	0.5 mm <sup>2</sup> ... 2.5 mm <sup>2</sup> AWG 14	16 A	500 V	Female		1079554
					Male		1079553
	Crimp (CT)	0.5 mm <sup>2</sup> ... 4 mm <sup>2</sup> AWG 12	16 A	500 V	Female		1079547
					Male		1079548

## COMPACT series housings

**i** Web code: #2157

	Version	Plastic (IP66)	Metal
<b>Sleeve housings, M25</b>			
	Straight	1012520	1078590
	Side	1012581	1078592
<b>Panel mounting bases</b>			
	Straight	1012538	1078594
<b>Panel mounting bases</b>			
	Angled	1012433	1078593
<b>Surface mounting housings</b>			
		1079393	1078596
<b>Coupling housings</b>			
		1012521	1078595

For crimp contacts, see pages 22-23.  
For suitable cable glands, see page 32 onwards.





 Denotes **HeavyCORE** stock designation product



## EVO M1 housings and PE modules



Use any single-slot modular insert from pages 18-19 with EVO M1.

\* Exception – 5-pos. Twin-PT insert is not recommended for use with EVO M1

	Module slots	Size	Locking	Type	Order no.
<b>EVO M1 housings for one modular contact insert</b>					
	<b>Sleeve housings</b>				
		1 1/2	M1	For single-locking latch	HC-EVO-M1-HHFS-PLBK 1424436
	<b>Panel mounting bases</b>				
		1 1/2	M1	With single-locking latch	HC-EVO-M1-BVVS-PLRBK 1424437
	<b>1/2 PE contact insert modules</b>				
		1/2		Female	HC-1/2M-UT-F-6-PE 1424438
	1/2		Male	HC-1/2M-UT-M-6-PE 1424439	

For suitable cable glands, see below.

## EVO bayonet adapters for use with EVO M1





	Cable Ø in mm	Thread	Plastic
<b>EVO cable gland with bayonet locking</b>			
	7 ... 13		1411350
	9 ... 17		1411351
<b>EVO thread adapter</b>			
		M25	1411352
		PG16	1411353
<b>Conduit adapter</b>			
		M25	3240899
		PG16	3240891

Denotes HeavyCORE stock designation product



# Contact inserts for D15, D25, D50 housings

**i** Web code: #1952

	Connection	Connection cross-section IEC // UL	Rated current IEC // UL	Rated voltage IEC // UL	Version	Housing size		
						D15	D25	D50
<b>A series</b>						<b>Number of positions</b>		
						<b>10</b>	<b>16</b>	<b>2 x 16</b>
	Push-in (PT)	0.14 mm <sup>2</sup> ... 2.5 mm <sup>2</sup> AWG 14	16 A // 16 A	250 V // 600 V	Female	1585362	1585388	1585388
					Male	1585359	1585375	1585375
	Screw (UT)	0.14 mm <sup>2</sup> ... 2.5 mm <sup>2</sup> AWG 14	16 A // 18 A	250 V // 600 V	Female	1585304	1585320	1585320
					Male	1585294	1585317	1585317
	Crimp CK 2,5 (CT)	0.5 mm <sup>2</sup> ... 4.0 mm <sup>2</sup> AWG 12	16 A // 16 A	250 V // 250 V	Female	1585427	1585443	1585443
					Male	1585414	1585430	1585430
<b>D series</b>						<b>Number of positions</b>		
						<b>15</b>	<b>25</b>	<b>2 x 25</b>
	Crimp CK 1,6 (CT)	0.14 mm <sup>2</sup> ... 2.5 mm <sup>2</sup> AWG 14	10 A // 10 A	250 V // 600 V	Female	1584389	1584402	1584402
					Male	1584376	1584392	1584392

For crimp contacts, see pages 22-23.

 Denotes **HeavyCORE** stock designation product

	Height	Thread	EVO Plastic (IP66)		STANDARD Metal (IP66/67)		
			D15	D25	D15	D25	D50
<b>Sleeve housings for single-locking latch</b>							
	Low	M20			1424350	1424381	
		Pg13.5			1424352		
		Pg16				1424383	
	High	M20	1411340	1411347			
		M25	1411340	1411347	1424351	1424382	1424408
		M32					1424409
		Pg16			1424353	1424384	
		Pg21			1424358	1424385	1424410
	Pg29					1424411	
	Low	M20			1424345	1424376	
		M25					1424402
		Pg16			1424347	1424378	
		Pg21					1424405
	High	M20	1411340	1411347			
		M25	1411340	1411347	1424346	1424377	1424403
		M32					1424404
		Pg16			1424348	1424379	
	Pg21			1424349	1424380	1424406	
	Pg29					1424407	
<b>Panel mounting bases with single-locking latch</b>							
	Without cover		1411336	1411344	1424362	1424391	1424412
	With cover		1411337	1411345	1424363	1424390	
<b>Surface mounting housings with single-locking latch</b>							
	Without cover	M20	1421463	1421466	1424364	1424392	
		M25	1411341	1411348	1424365	1424393	1424413
		M32					1424414
		Pg16			1424366	1424394	
		Pg21			1424367	1424395	1424415
		Pg29					1424416
	With cover	M20	1421465	1421467	1424369	1424396	
		M25	1411343	1411349	1424371	1424397	
		Pg16			1424372	1424398	
		Pg21			1424373	1424399	
<b>Coupling housings with single-locking latch</b>							
	High	M20	1411338	1411346			
		M25	1411338	1411346	1424361	1424387	
		Pg16			1424360	1424389	

For suitable cable glands, see page 32 onwards.

 Denotes **HeavyCORE** stock designation product

# Modular contact inserts for B housings and EVO M1

Power		Number of positions													
		1		1		2		2		2		2			
Connection		Axial screw		Axial screw		Axial screw		Axial screw		Axial screw		Push-in		Crimp CK 4,0	
IEC rated data		200 A, 1000 V, 70 mm <sup>2</sup>		PE, 70 mm <sup>2</sup>		100 A, 1000 V, 35 mm <sup>2</sup>		70 A, 1000 V, 25 mm <sup>2</sup>		40 A, 1000 V, 10 mm <sup>2</sup>		40 A, 1000 V V, 6 mm <sup>2</sup>		40 A, 1000 V, 10 mm <sup>2</sup>	
UL rated data		146 A, 600 V, AWG 0		AWG 0		127 A, 600 V, AWG 2		69 A, 600 V, AWG 6		55 A, 600 V, AWG 8		Pending approval		42 A, 600 V, AWG 10	
Module slots		2		2		2		1		1		1		1	
Female	Male	1417379	1417381	1417380	1417382	1417390	1417392	1417296	1417297	1417387	1417389	1424222	1424223	1414361	1414360
Connection		Push-in		Crimp CK 4,0		Crimp CK 4,0		Push-in		Crimp CK 4,0		Crimp CK 2,5		Push-in	
IEC rated data		40 A, 1000 V, 6 mm <sup>2</sup>		40 A, 830 V, 10 mm <sup>2</sup>		40/10 A, 830 V, 6/2.5 mm <sup>2</sup>		40 A, 1000 V, 6 mm <sup>2</sup>		40 A, 1000 V, 6 mm <sup>2</sup>		16 A, 5000 V, 4 mm <sup>2</sup>		16 A, 400 V, 2.5 mm <sup>2</sup>	
UL rated data		Pending approval		42 A, 600 V, AWG 10		40 A, 600 V, AWG 10		Pending approval		37 A, 600 V, AWG 10		28 A, 600 V, AWG 12		19 A, 600 V, AWG 14	
Module slots		1		1		1		1		1		2		1	
Female	Male	1424218	1424219	1414359	1414358	1414365	1414364	1424220	1424221	1414362	1414363	1417407	1417408	1417373	1417372
Connection		Push-in TWIN		Push-in		Crimp CK 2,5		Crimp CK 2,5		Push-in		Crimp CK 2,5		Crimp CK 2,5	
IEC rated data		16 A, 400 V, 1.5 mm <sup>2</sup>		16 A, 500 V, 2.5 mm <sup>2</sup>		16 A, 830 V, 4 mm <sup>2</sup>		16 A, 830 V, 4 mm <sup>2</sup>		16 A, 690 V, 2.5 mm <sup>2</sup>		16 A, 500 V, 4 mm <sup>2</sup>		16 A, 400 V, 2.5 mm <sup>2</sup>	
UL rated data		16 A, 600 V, AWG 16		16 A, 600 V, AWG 14		24 A, 600 V, AWG 12		24 A, 600 V, AWG 12		16 A, 600 V, AWG 14		20 A, 600 V, AWG 12		17.5 A, 600 V, AWG 12	
Module slots		1		1		1		1		1		1		2	
Female	Male	1423962	1423961	1424224	1424225	1414369	1414368	1414367	1414366	1424226	1424227	1414371	1414370	1414373	1414372
<b>Signal</b>		<b>Number of positions</b>													
		12		12		17		25							
Connection		Push-in		Crimp CK 1,6		Crimp CK 1,6		Crimp D-SUB							
IEC rated data		10 A, 400 V, 1.5 mm <sup>2</sup>		10 A, 250 V, 2.5 mm <sup>2</sup>		10 A, 160 V, 2.5 mm <sup>2</sup>		4 A, 60 V, 0.5 mm <sup>2</sup>							
UL rated data		10 A, 600 V, AWG 16		16 A, 600 V, AWG 14		14 A, 600 V, AWG 14		5 A, 50 V, AWG 20							
Module slots		1		1		1		1							
Female	Male	1424228	1424246	1414355	1414354	1414357	1414356	1414375	1414374						
<b>Data</b>		<b>Number of positions</b>													
		9		2		8		4		4					
Connection		Crimp D-SUB		Screw		Crimp D-SUB		Coax crimp		Coaxial crimp contacts					
Data transmission rate				12 Mbps PROFIBUS		CAT6 <sub>A</sub> , 10 Gbps				≤2 GHz					
IEC rated data		1 A, 48 V, 0.5 mm <sup>2</sup>		1 A, 48 V, 0.5 mm <sup>2</sup>		5 A, 48 V, 0.5 mm <sup>2</sup>				75 Ω		50 Ω			
UL rated data						5 A, 50 V, AWG 22				Male/fem.		Male/fem.			
Module slots		1		1		1		1		1655629		1655580			
Female	Male	1417308	1417309	1417307	1423723	1417303	1417302	1417370	1417371	1655616	1655577				
Connection		RJ45 gender changer		RJ45, crimp		RJ Industrial, IDC		RJ Industrial, IDC		RJ45 patch cable					
Data transmission rate		10 Gbps, 500 MHz		10 Gbps, 500 MHz		1 Gbps, 100 MHz		1 Gbps, 100 MHz		10 Gbps, 500 MHz					
Description		CAT6 <sub>A</sub>		CAT6 <sub>A</sub>		For RJ Industrial, IDC		CAT5(e)		CAT6 <sub>A</sub>		For RJ45 patch cables			
Module slots		1		1		1		AWG 26-24/23-22		AWG 26-24/23-22		1			
Female		1419886		1419887		1419888		1421608/1421129		1157964/1157963		1419885*			

\* Suitable patch cables can be found in the accessories section of the module 1419885 in our e-shop. For crimp contacts, see pages 22-23.

Denotes **HeavyCORE** stock designation product



Data		Number of positions									
		8		4		1		1			
Connection		EMC		Crimp D-SUB		Crimp CK 1,6		Crimp CK 1,6		Crimp CK 2,5	
Data transmission rate		CAT5(e), 100 Mbps		CAT5(e), 100 Mbps		500 MHz, 75 Ω coax		500 MHz, 75 Ω coax		500 MHz, 50 Ω coax	
IEC rated data		5 A, 48 V, 0.52 mm <sup>2</sup>		10 A, 48 V, 2.5 mm <sup>2</sup>		10 A, 48 V		10 A, 48 V		16 A, 48 V	
UL rated data				10 A, 42 V, AWG 16		10 A, 50 V		10 A, 50 V			
Module slots		2		-		-		-		-	
Female	Male	1417376	1417374	1066080	1066082	1636091	1636088	1066961	1066962	1066959	1066960
Pneumatics		Number of positions									
		2		3		3		3		3	
Hose inner Ø		6 mm		6 mm		1.6 mm		1.6 mm		3 mm	
Module slots		1		1		1		1		1	
Male		1417434		1676750		1417433		1663488		1663491	
Socket without valve		1417434		1676763		1417433		1663514		1663527	
Socket with valve		1417434		1676776		1417433		1663543		1663556	

Dummy module
-
-
-
-
1
1414353

Denotes **HeavyCORE** stock designation product

## Snap-in frames for modular contact inserts







	Module slots	Housing size	Dimensions		Type	Order no.
			a (mm)	b (mm)		
<b>Module carrier frames with side latch springs</b>						
	<b>For sleeve housings (A, B, C, etc.)</b>					
	2	B06	44.0	51.0	HC-M-B06-MFH-H	1182087
	3	B10	57.0	64.0	HC-M-B10-MFH-H	1182089
	4	B16	77.5	84.5	HC-M-B16-MFH-H	1182093
	6	B24	104.0	111.0	HC-M-B24-MFH-H	1182095
	<b>For panel mounting bases, surface mounting housings, and coupling housings (a, b, c, etc.)</b>					
	2	B06	44.0	51.0	HC-M-B06-MFH-B	1182085
	3	B10	57.0	64.0	HC-M-B10-MFH-B	1182088
	4	B16	77.5	84.5	HC-M-B16-MFH-B	1182090
	6	B24	104.0	111.0	HC-M-B24-MFH-B	1182094

## Snap-in advantages

- ✓ Robust stainless-steel retention springs allow the user to individually insert or remove modules easily
- ✓ Eliminates the need for accessories to secure the frame
- ✓ Compatibility with all standard modular inserts
- ✓ Spring design enables the installation of inserts in a pre-mounted frame
- ✓ Assured compatibility with all HEAVYCON B-series housings and all industry-standard housings
- ✓ Approved by UL, CSA, and CE for global acceptance









# Contact inserts with a fixed number of positions for B housings

	Connection	Connection cross-section IEC // UL	Rated current IEC // UL	Rated voltage IEC // UL	Version	Housing size					
						B06	B10	B16	B24	B32	B48
						Number of positions					
<b>B series</b>						<b>6</b>	<b>10</b>	<b>16</b>	<b>24</b>	<b>32</b>	<b>48</b>
	Push-in (PT) with "Click-in" Mounting	0.14 mm <sup>2</sup> ... 2.5 mm <sup>2</sup> AWG 14	16 A // 13 A	500 V // 600 V	Female	1350024	1350017	1350013	1350010	1350013	1350010
					Male	1350025	1350020	1350015	1350011	1350015	1350011
	Push-in (PT)	0.14 mm <sup>2</sup> ... 2.5 mm <sup>2</sup> AWG 14	16 A // 13 A	500 V // 600 V	Female	1407727	1407729	1407731	1407735	1407731	1407735
					Male	1407728	1407730	1407732	1407736	1407732	1407736
	TWIN Push-in (TPT)	0.25 mm <sup>2</sup> ... 1.5 mm <sup>2</sup> AWG 16	16 A // 11 A	500 V // 600 V	Female	1423016	1423018	1423020	1423022	1423020	1423022
					Male	1423015	1423017	1423019	1423021	1423019	1423021
	Screw (UT)	0.5 mm <sup>2</sup> ... 2.5 mm <sup>2</sup> AWG 14	16 A // 14 A	500 V // 600 V	Female	1648128	1648186	1648241	1648306	1648241	1648306
					Male	1648115	1648173	1648238	1648296	1648238	1648296
	Crimp CK 2,5 (CT)	0.5 mm <sup>2</sup> ... 4.0 mm <sup>2</sup> AWG 14	16 A // 14 A	500 V // 600 V	Female	1648160	1648225	1648283	1648348	1648283	1648348
					Male	1648157	1648212	1648270	1648335	1648270	1648335
	IDC (QT)	0.34 mm <sup>2</sup> ... 2.5 mm <sup>2</sup> AWG 14	16 A // 10 A	500 V // 600 V	Female	1605556	1605569	1605572	1605585	1605572	1605585
					Male	1605611	1605624	1605637	1605640	1605637	1605640
<b>BB series</b>						<b>10</b>	<b>18</b>	<b>32</b>	<b>46</b>	<b>64</b>	<b>92</b>
	Push-in (PT)	0.5 mm <sup>2</sup> ... 2.5 mm <sup>2</sup> AWG 14	16 A // 14-21 A	500 V // 600 V	Female	1014417	1014419	1014421	1014423	1014421	1014423
					Male	1014418	1014420	1014422	1014424	1014422	1014424
	Crimp CK 2,5 (CT)	0.5 mm <sup>2</sup> ... 4.0 mm <sup>2</sup> AWG 12	16 A // 16 A	500 V // 600 V	Female	1584703	1584729	1584745	1584758	1584745	1584758
					Male	1584774	1584716	1584732	1584761	1584732	1584761
<b>BBB series</b>								<b>40</b>	<b>64</b>	<b>2x40</b>	<b>2x64</b>
	Crimp CK 2,5 (CT)	0.5 mm <sup>2</sup> ... 4.0 mm <sup>2</sup> AWG 12	16 A // 16 A	500 V // 600 V	Female			1409930	1409914	1409930	1409914
					Male			1409921	1409901	1409921	1409901

For crimp contacts, see pages 22-23.

 Denotes **HeavyCORE** stock designation product

	Connection	Connection cross-section IEC // UL	Rated current IEC // UL	Rated voltage IEC // UL	Version	Housing size					
						B06	B10	B16	B24	B32	B48
<b>D series</b>						<b>Number of positions</b>					
								40	64	80	128
	Crimp CK 1,6 (CT)	0.14 mm <sup>2</sup> ... 2.5 mm <sup>2</sup> AWG 14	10 A//10 A	250V//600V	Female			1584428	1584444	1584428	1584444
					Male			1584415	1584431	1584415	1584431
<b>DD series</b>						<b>Number of positions</b>					
						24	42	72	108	144	216
	Crimp CK 1,6 (CT)	0.14 mm <sup>2</sup> ... 2.5 mm <sup>2</sup> AWG 14	10 A//7 A	250V//250V	Female	1584046	1584062	1584091	1584130	1584091	1584130
					Male	1584033	1584059	1584075	1584114	1584075	1584114
										1584088	1584127





<b>HS series</b>						<b>Number of positions</b>					
								6		12	
	Push-in (PT)	1.5 mm <sup>2</sup> ... 6.0 mm <sup>2</sup> AWG 10	41 A	400/690V	Female			1031080			
					Male			1031082			
	Screw (UT)	0.5 mm <sup>2</sup> ... 6.0 mm <sup>2</sup> AWG 10	41 A//35 A	400/690V// 600V	Female			1406530		1406530	
					Male			1406531		1406531	
										1406534	
<b>HV series</b>						<b>Number of positions</b>					
							3	6	10		
	Push-in (PT)	0.14 mm <sup>2</sup> ... 2.5 mm <sup>2</sup> AWG 14	16 A//20 A	830V//600V	Female		1407743	1407744	1407745		
					Male		1407739	1407740	1407741		
	Crimp CK 2,5 (CT)	0.5 mm <sup>2</sup> ... 4.0 mm <sup>2</sup> AWG 12	16 A//16 A	830V//600V	Female		1405261	1405263	1405265		
					Male		1405260	1405262	1405264		
<b>K series</b>						<b>Number of positions</b>					
								6			
	Screw (UT)	6 mm <sup>2</sup> ... 16 mm <sup>2</sup> AWG 6	80 A//80 A	1000V//600V	Female			1580537			
					Male			1580538			

For crimp contacts, see pages 22-23.

 Denotes **HeavyCORE** stock designation product





# Crimp contacts

**i** Web code: #1934

	For cross-section (mm <sup>2</sup> )	AWG	Silver		Male, lagging	Gold	
			Female	Male		Female	Male
<b>CK 1,6-ED, turned</b>							
	0.14 ... 0.37	26 ... 22	1663394	1663336		1674969	1674901
	0.5	20	1663404	1663349		1674480	1672453
	0.75	18	1663417	1663352		1672440	1674914
	1.0	18	1663420	1663365		1674943	1674888
	1.5	16	1663433	1663378		1674930	1674875
	2.5	14	1663446	1663381		1674985	1674927
<b>CK 2,5-ED, turned</b>							
	0.5	20	1663640	1663572		1674859	1674804
	0.75	18	1663653	1663585			
	0.75 ... 1.0	18	1663666	1663598	1663857	1674833	1674781
	1.5	16	1663679	1663608	1663860	1674820	1674778
	2.5	14	1663682	1663611	1663873	1674862	1674817
	4.0	12	1663705	1663637		1674846	1674794
<b>CK 4,0-ED, turned</b>							
	1.5	16	1663271	1663239			
	2.5	14	1663284	1663242			
	4.0	12	1663297	1663255			
	6.0	10	1663307	1663268			
	10.0	8	1586183	1586198			
<b>D-SUB</b>							
	0.08 ... 0.2	28 ... 26				1418787	1418784
	0.2 ... 0.5	24 ... 20				1418788	1418786

With positioning aid	Without positioning aid		Dies		Removal tool	
<b>Tools for CK 1,6-ED</b>						
	1297083					 1072069
<b>Tools for CK 2,5-ED</b>						
	1297083		1212072		1212075	 1072067
<b>Tools for CK 4,0-ED</b>						
	1297083		1212072		1212075	 1072064
	1314533*				1212076*	
<b>Tools for D-SUB</b>						
	1212510				1045123	 1658794

\* For cross-sections 6 ... 10 mm<sup>2</sup> / AWG 10 ... 8.

	For cross-section (mm <sup>2</sup> )	AWG	Silver	
			Female	Male
<b>CK 1,6-ER, punched, single</b>				
	0.34 ... 1.0	22 ... 18	1004362	1004360
	1.5 ... 2.5	16 ... 14	1004366	1004365
<b>CK 1,6-BR, punched, taped products</b>				
	0.34 ... 1.0	22 ... 18	1004381	1004380
	1.5 ... 2.5	16 ... 14	1004383	1004382
<b>Tools for CK 1,6-ER, punched, single</b>				
	0.34 ... 2.5	22 ... 14	1069228	
<b>Tools for CK 1,6-BR, punched, taped products*</b>				
	0.34 ... 1.0	22 ... 18	20.2001-1004380/4381*	
	1.5 ... 2.5	16 ... 14	20.2001-1004382/4383*	

\* Kolb offers a tool for the automatic processing of these contacts on crimping devices.

U. Kolb GmbH, Neuer Weg 32, 71111 Waldenbuch, Germany, Telephone: +49 7157 7371-0, E-mail: [info@u-kolb-gmbh.de](mailto:info@u-kolb-gmbh.de), [www.u-kolb-gmbh.de](http://www.u-kolb-gmbh.de)

## Punch-rolled crimp contact advantages

- ✓ Quick and easy processing with open crimping
- ✓ High degree of efficiency with fully automated processing of the taped product
- ✓ Single contacts for processing in the field
- ✓ Installation in standard crimp inserts with incorrect insertion protection in the contact sockets
- ✓ Two contact sizes cover all conductor cross-sections from 0.34 mm<sup>2</sup> to 2.5 mm<sup>2</sup>



The crimp contacts are suitable for all standard contact inserts (fixed number of positions and modular).



# Single-latch EVO B plastic housings

	Height	Thread	Metric			
			B06	B10	B16	B24
<b>Sleeve housings for single-locking latch</b>						
	Low		1407619	1407626	1420931	1420934
	High		1407620	1407627	1407642	1407656
<b>Sleeve housings for single-locking latch with two cable outlets</b>						
	High		1420930			
<b>Panel mounting bases with single-locking latch</b>						
	Without cover		1407621	1407632	1407646	1407659
	With cover		1407622	1407633	1407647	1407660
<b>Surface mounting housings with single-locking latch</b>						
	High, without cover	M20	1421322	1421354		
		M25	1421229	1421277	1421381	1421459
		M32	1407623	1407636	1421363	1421367
		M40			1407650	1407663
	High, with cover	M20	1421329	1421355		
		M25	1421244	1421301	1421382	1421460
		M32	1407624	1407637	1421364	1421369
		M40			1407651	1407664
<b>Coupling housings with single-locking latch</b>						
	High		1407625	1407640	1407654	1407667

For suitable cable glands, see page 32 onwards.

 Denotes **HeavyCORE** stock designation product



# Double-latch EVO B plastic housings

**i** Web code: #1950

	Height	Thread	Metric		
			B10	B16	B24
<b>Sleeve housings for double-locking latch</b>					
	Low		1407628	1420932	1420935
	High		1407629	1407643	1407657
<b>Sleeve housings for double-locking latch with two cable outlets</b>					
	High		1411495	1411496	1411497
<b>Panel mounting bases with double-locking latch</b>					
	Without cover		1407634	1407648	1407661
<b>Surface mounting housings with double-locking latch</b>					
	High, without cover	M20	1421356		
		M25	1421304	1421455	1421461
		M32	1407638	1421365	1421370
		M40		1407652	1407665
<b>Coupling housings with double-locking latch</b>					
	High		1407641	1407655	1407668
<b>Sleeve housings with double-locking latch</b>					
	Low		1407630	1420933	1420936
	High		1407631	1407644	1407658
<b>Panel mounting bases for double-locking latch</b>					
	With cover		1407635	1407649	1407662
<b>Surface mounting housings for double-locking latch</b>					
	High, with cover	M20	1421362		
		M25	1421320	1421458	1421462
		M32	1407639	1421366	1421380
		M40		1407653	1407666

For suitable cable glands, see page 32 onwards.

 Denotes **HeavyCORE** stock designation product







## Single-latch EVO and STANDARD B metal housings

	Height	Thread	Metric					Thread	Pg				
			B06	B10	B16	B24	B48		B06	B10	B16	B24	B48
<b>EVO sleeve housings for single-locking latch</b>													
	Low		1411448	1411456					1411448	1411456			
	High*		1411447	1411453	1411461	1411473			1411447	1411453	1411461	1411473	
<b>STANDARD sleeve housings for single-locking latch</b>													
	Straight low	M20	1412574	1412629				Pg13.5	1412576				
		M25	1412575	1412630	1412729	1412788		Pg16	1412577	1412631	1412731	1412790	
		M32			1412730	1412789		Pg21		1412632	1412732	1412791	
	Straight high*	M25	1412566	1412604				Pg21	1412568	1412606	1412701	1412762	
		M32	1412567	1412605	1412689	1412761	1424854	Pg29	1412569	1412607	1412702	1412763	1424851
		M40			1412700	1412098	1424855	Pg36					1424852
		M50					1424856	Pg42					1424853
	Side low	M20	1412570	1412624				Pg13.5	1412572				
		M25	1412571	1412625	1412725	1412783		Pg16	1412573	1412627	1412727	1412785	
		M32			1412726	1412784		Pg21		1412628	1412728	1412786	
	Side high*	M25	1412562	1412600				Pg21	1412564	1412602	1412683	1412759	
		M32	1412563	1412601	1412679	1412757	1424860	Pg29	1412565	1412603	1412684	1412760	1424857
		M40			1412682	1412758	1424861	Pg36					1424858
		M50					1424862	Pg42					1424859
	Low	Without thread	1419900	1419902	1419905	1419937		Without thread	1419900	1419902	1419905	1419937	
	High*		1419901	1419903	1419934	1419957			1419901	1419903	1419934	1419957	

\* For modular contact inserts and contact inserts with a fixed high number of positions.  
For suitable cable glands, see page 32 onwards.

 Denotes **HeavyCORE** stock designation product

# Single-latch EVO and STANDARD B metal housings

	Height	Thread	Metric					Thread	Pg				
			B06	B10	B16	B24	B48		B06	B10	B16	B24	B48
<b>Panel mounting bases with single-locking latch</b>													
	Without cover		1411318	1411320	1411324	1411329	1424863		1411318	1411320	1411324	1411329	1424863
	With cover		1411319	1411321	1411325	1411330	1424864		1411319	1411321	1411325	1411330	1424864
<b>Surface mounting housings with single-locking latch</b>													
	Low, without cover	M20	1412821	1412839				Pg16	1412823	1412842			
		M25	1412822	1412840	1412861	1412877		Pg21	1412824	1412843	1412863	1412879	
		M32			1412862	1412878		Pg29					
		M40						Pg36					
	High*, without cover	M25	1082556	1082578	1082586								
		M32	1082559	1082579	1082587	1082592	1424867	Pg29					1424865
		M40	1082566	1082580	1082588	1082593	1424868	Pg36					1424866
	Low, with cover	M20	1412825	1412844				Pg16	1412827	1412846			
		M25	1412826	1412845	1412865	1412881		Pg21			1412867	1412883	
		M32			1412866	1412882		Pg29					
	High*, with cover	M25	1082575	1082582	1082589	1082595							
		M32	1082576	1082583	1082590	1082596	1424873	Pg29					1424869
		M40	1082577	1082585	1082591	1082597	1424874	Pg36					1424872
<b>Coupling housings with single-locking latch</b>													
	High*	M20	1412555	1412584				Pg16		1412587			
		M25	1412556	1412585	1412645			Pg21	1412559	1412588	1412647	1412748	
		M32	1412557	1412586	1412646	1412746		Pg29	1412560	1412589	1412648	1412749	
		M40				1412747		Pg36					







\* For modular contact inserts and contact inserts with a fixed high number of positions.  
For suitable cable glands, see page 32 onwards.

 Denotes **HeavyCORE** stock designation product



# Double-latch EVO and STANDARD B metal housings







**i** Web code: #1954

	Height	Thread	Metric				Thread	Pg			
			B10	B16	B24	B32		B10	B16	B24	B32
<b>EVO sleeve housings for double-locking latch</b>											
	Low		1411455					1411455			
	High*		1411451	1411460	1411472			1411451	1411460	1411472	
<b>STANDARD sleeve housings for double-locking latch</b>											
	Straight low	M20	1412620				Pg13.5				
		M25	1412621	1412721	1412778		Pg16	1412622	1412723	1412780	
		M32		1412722	1412779		Pg21	1412623	1412724	1412781	
	Straight high*	M25	1412596				Pg21	1412598	1412669	1412755	
		M32	1412597	1412653	1412754	1424830	Pg29	1412599	1412678	1412756	1424827
		M40		1412654	1412099	1424831	Pg36				1424828
	Side low	M20	1412616				Pg13.5				
		M25	1412617	1412717	1412773		Pg16	1412618	1412719	1412775	
		M32		1412718	1412774		Pg21	1412619	1412720	1412776	
	Side high*	M25	1412592				Pg21	1412594	1412651	1412752	
		M32	1412593	1412649	1412750	1424836	Pg29	1412595	1412652	1412753	1424833
		M40		1412650	1412751	1424837	Pg36				1424834
	Low	Without thread	1419972	1419999	1420010		Without thread	1419972	1419999	1420010	
	High*		1419979	1420000	1420011			1419979	1420000	1420011	
<b>Panel mounting bases with double-locking latch</b>											
	Without cover		1411322	1411327	1411331	1424845	Without cover	1411322	1411327	1411331	1424845
<b>Surface mounting housings with double-locking latch</b>											
	Low, without cover	M20	1412835				Pg16	1412837			
		M25	1412836	1412855	1412873		Pg21	1412838	1412857	1412875	
		M32		1412856	1412874		Pg29		1412860	1412876	
		M40					Pg36				
	High, without cover	M25	1082598	1082600	1082603						
		M32	1082599	1082601	1082604	1424848	Pg29				1424846
	M40	1083164	1082602	1082605	1424849	Pg36				1424847	
<b>Coupling housings with double-locking latch</b>											
	High	M20	1412578				Pg16	1412581			
		M25	1412579	1412641			Pg21	1412582	1412643	1412744	
		M32	1412580	1412642	1412742	1424842	Pg29	1412583	1412644	1412745	1424839
		M40			1412743	1424843	Pg36				1424840
		M50				1424844	Pg42				1424841

\* For modular contact inserts and contact inserts with a fixed high number of positions.  
For suitable cable glands, see page 32 onwards.

 Denotes **HeavyCORE** stock designation product



	Height	Thread	Metric			Thread	Pg		
			B10	B16	B24		B10	B16	B24
<b>EVO sleeve housings with double-locking latch</b>									
	Low		1411457				1411457		
	High*		1411454	1411462	1411474		1411454	1411462	1411474
<b>STANDARD sleeve housings with double-locking latch</b>									
	Straight low	M20	1412637			Pg16	1412639	1412740	1412801
		M25	1412638	1412738	1412799	Pg21	1412640	1412741	1412802
		M32		1412739	1412800	Pg29			1412803
	Straight high*	M25	1412612			Pg21	1412614	1412715	1412771
		M32	1412613	1412708	1412769	Pg29	1412615	1412716	1412772
		M40		1412709	1412770				
	Side low	M20	1412633			Pg16	1412635	1412735	1412796
		M25	1412634	1412733	1412793	Pg21	1412636	1412737	1412797
		M32		1412734	1412795	Pg29			
	Side high*	M25	1412608			Pg21	1412610	1412705	1412767
		M32	1412609	1412703	1412764	Pg29	1412611	1412706	1412768
		M40		1412704	1412766				
	Low	Without thread	1420034	1420036	1420046	Without thread	1420034	1420036	1420046
	High*		1420035	1420044	1420047		1420035	1420044	1420047
<b>Panel mounting bases for double-locking latch</b>									
	With cover		1411323	1411328	1411332		1411323	1411328	1411332
<b>Surface mounting housings for double-locking latch</b>									
	With cover	M20	1412830			Pg16	1412832	1412852	
		M25	1412831	1412849	1412869	Pg21		1412853	1412871
		M32		1412850	1412870	Pg29			

\* For modular contact inserts and contact inserts with a fixed high number of positions.  
For suitable cable glands, see page 32 onwards.









	Material	Height	Thread	Metric				
				B06	B10	B16	B24	
<b>Sleeve housings with screw-locking mechanism</b>								
	Plastic	Straight high	M20	1404222				
			M25	1404225	1404227			
M32				1404229	1404231	1404235		
M40					1404233	1404238		
		Side high	M20	1404224				
			M25	1404226	1404228			
			M32		1404230	1404232	1404237	
			M40			1404234	1404239	
	Metal (aluminum)	Straight low	M20	1413362	1413388			
			M25	1413364	1413390	1414975	1414982	
		Straight high*	M25	1413374	1413400	1414977	1414980	
			M32	1413376	1413402	1413416	1413430	
			M40		1072331	1413418	1413432	
			Side low	M20	1413363	1413389		
				M25	1413365	1413391	1414976	1414983
				Side high*	M25	1413375	1413401	1414978
M32	1413377				1413403	1413417	1413431	
	Side high*	M40			1413419	1413433		
		Straight low	M20	1420904	1420912			
			M25	1420905	1420913	1420921	1420929	
		Straight high*	M25	1420900	1420908	1420917	1420925	
			M32	1420901	1420909	1420918	1420926	
			M40			1420919	1420927	
			Side low	M20	1420902	1420910		
M25	1420903			1420911	1420920	1420928		
Side high*	M25			1420898	1420906	1420914	1420922	
	M32			1420899	1420907	1420915	1420923	
	Side high*	M40			1420916	1420924		
<b>Panel mounting flanges</b>								
		Single, without screws		1686533	1686533	1686533	1686533	
		Set of 2 with screws		1604638	1604638	1604638	1604638	
<b>Covers</b>								
	Plastic	For panel mounting side (IP66)		1411494	1411504	1411517	1411520	
		For sleeve side (IP50)		1690736	1690749	1690752	1690765	
<b>Sleeve housings</b>								
	Metal (aluminum)	Low	Without thread	1420048	1420051	1420053	1420055	
		High		1420050	1420052	1420054	1420056	









\* For modular contact inserts and contact inserts with a fixed high number of positions.  
For suitable cable glands, see page 32 onwards.

Denotes **HeavyCORE** stock designation product

	Height	Thread	Metric			
			B06	B10	B16	B24
<b>Sleeve housings with screw-locking mechanism</b>						
	Straight high	M20	1411879			
		M25	1411106	1411882		
		M32		1411067	1411059	1411888
		M40			1411885	1411062
	Side high	M20	1411878			
		M25	1411119	1411881		
		M32		1411070	1411058	1411887
		M40			1411884	1411061
<b>Panel mounting bases for screw-locking mechanism</b>						
	Without cover		1411122	1411083	1411060	1411055
	With cover					
<b>Surface mounting housings for screw-locking mechanism</b>						
	Without cover	M20	1411880			
		M25	1411135	1411883		
		M32		1411096	1411054	1411889
		M40			1411886	1411063
<b>Covers with screw-locking mechanism</b>						
	For panel mounting side		1418441	1418444	1418445	1418446
	For sleeve housing side					

For suitable cable glands, see page 32 onwards.

# Cable glands and adapters, plastic

Cable glands										
										
Thread	Cable diameter (mm)		Gray	Black	EVO D housings		EVO B housings		Bending protection	Strain relief
	Min.	Max.			Bayonet lock	Thread adapter	Bayonet lock	Thread adapter		
M20	6	12	1411125	1411133						
	6	13							1415179	1415189
	7	13			1411350		1407669			
	9	13						1414243		
	9	17								
	10	14	1424476	1424481						
	11	16								
M25	9	17			1411351		1407670		1415180	1415190
	10	14								
	11	16								
	11	17	1411126	1411134		1411352		1414244		
	13	18	1424477	1424482						
	14	21								
M32	11	21					1407671			
	13	18								
	13	21							1415181	1415191
	14	21						1414245		
	15	21	1411127	1411136						
	18	25	1424478	1424483						
	19	27								
M40	18	25								
	19	27								
	19	28	1411128	1411137			1407672	1414246		
	27	34								
M50	22	32								
	24	35								
	27	38								
	30	36	1411129	1411138						
Pg13.5	6	12	1411143	1424498			1414247			
Pg16	10	14	1411144	1424499		1411353	1414248			
Pg21	13	18	1411145	1424500			1414249			
Pg29	18	25	1411146	1424501			1414250			
Pg36	22	32	1411147	1424502						
Pg42	30	38	1411148	1424503						

You will find additional cable glands and screw connections for protective hoses at [phoenixcontact.com](http://phoenixcontact.com)

 Denotes **HeavyCORE** stock designation product

**Corrugated pipe adapters**



Thread	Protective hose outside diameter (mm)	For plastic protective hoses						For protective hoses with coated spirals	
		Straight				Angled		Cannot be rotated	Can be rotated
		Without strain relief		With strain relief		Without strain relief			
		IP66	IP69	IP66	IP69	IP66	IP69	IP54	
M20	21							3240998	3241012
	21.2	3240898	3240884	3240954	3240940	3240926	3240912		
M25	27							3240999	3241013
	28.5	3240899	3240885	3240955	3240941	3240927	3240913		
M32	34.5	3240900	3240886	3240956	3240942	3240928	3240914		
	36							3241000	3241014
M40	42.5	3240901	3240887	3240957	3240943	3240929	3240915		
	45							3241001	3241015
Pg16	21.2	3240891	3240877	3240947	3240933	3240919	3240905		
	21							3240991	3241005
Pg21	27							3240992	3241006
	28.5	3240892	3240878	3240948	3240934	3240920	3240906		
Pg29	34.5	3240893	3240879	3240949	3240935	3240921	3240907		
	36							3240993	3241007
Pg36	42.5	3240894	3240880	3240950	3240936	3240922	3240908		
	45							3240994	3241008

**Protective hose/flexible conduit**

For thread	Outside diameter (mm)	Inside diameter (mm)	PA V0, slotted	PA V0	PA HB	Uncoated spiral	
						PVC	PU
M20//Pg16	21	16				3240852	3240859
	21.2	16.5	3240845	3240683	3240841		
M25//Pg21	27	22				3240853	3240860
	28.5	23	3240846	3240684	3240842		
M32//Pg29	34.5	29	3240847	3241088	3240843		
	36	29				3240854	3240861
M40//Pg36	42.5	36	3240848	3241089	3240844		
	45	38				3240855	3240862







**Reducing adapters**

	Thread	PA HB
	M25 / M20	1411232
	M32 / M20	1410725
	M32 / M25	1410712
	M40 / M25	1410741
	M40 / M32	1410738

Denotes HeavyCORE stock designation product



# Cable glands and adapters, metal

Cable glands										
										
Thread	Cable diameter (mm)		Nickel-plated brass	EMC	EVO B housings			Bending protection	Strain relief	
	Min.	Max.			Bayonet lock		Thread adapter			
					Die-cast aluminum	EMC				
M20	6	12	1411163				1414256			
	6	13						1415182	1415192	
	7	13			1411442					
	9	13		1411189		1411439				
	9	17								
	10	14								
	11	16	1645998							
M25	9	17					1414257	1415183	1415193	
	10	14	1424527							
	11	16		1411190	1411443	1411446				
	11	17	1411165							
	13	18								
	14	21	1646007							
M32	11	21					1414258	1415184	1415194	
	13	18	1424528							
	13	21								
	14	21		1411191	1411444	1411440				
	15	21	1411166							
	18	25								
	19	27	1646010							
M40	18	25	1424529				1414259	1415185	1415195	
	19	27		1411192	1411445	1411441				
	19	28	1411167							
	27	34	1607729							
M50	22	32	1424530							
	24	35		1411193						
	27	38	1411168							
Pg13.5	6	12	1411173	1411198			1414260			
Pg16	10	14	1411174	1411199			1414261			
Pg21	13	18	1411175	1411200			1414262			
Pg29	18	25	1411176	1411201			1414263			
Pg36	22	32	1411178	1411202						
Pg42	30	38	1411179	1411203						

 Denotes **HeavyCORE** stock designation product



## Corrugated pipe adapters

Corrugated pipe adapters				
				
Thread	Protective hose outside diameter (mm)	For metal protective hoses		
		Cannot be rotated		Can be rotated
		IP40	IP65	IP40
M20	21	<a href="#">3241047</a>	<a href="#">3241061</a>	<a href="#">3241033</a>
M25	27	<a href="#">3241048</a>	<a href="#">3241062</a>	<a href="#">3241034</a>
M32	36	<a href="#">3241049</a>	<a href="#">3241063</a>	<a href="#">3241035</a>
M40	45	<a href="#">3241050</a>	<a href="#">3241064</a>	<a href="#">3241036</a>
Pg16	21	<a href="#">3241040</a>	<a href="#">3241054</a>	<a href="#">3241026</a>
Pg21	27	<a href="#">3241041</a>	<a href="#">3241055</a>	<a href="#">3241027</a>
Pg29	36	<a href="#">3241042</a>	<a href="#">3241056</a>	<a href="#">3241028</a>
Pg36	45	<a href="#">3241043</a>	<a href="#">3241057</a>	<a href="#">3241029</a>

## Protective hose/flexible conduit



For thread	Outside diameter (mm)	Inside diameter (mm)	Steel, galvanized	Stainless steel	Galvanized steel, PVC coated
M20 // Pg16	21	16			<a href="#">3240870</a>
		18	<a href="#">3240699</a>	<a href="#">3240688</a>	
M25 // Pg21	27	22			<a href="#">3240871</a>
		23	<a href="#">3240866</a>	<a href="#">3240864</a>	
M32 // Pg29	36	29			<a href="#">3240872</a>
		31	<a href="#">3240700</a>	<a href="#">3240689</a>	
M40 // Pg36	45	38			<a href="#">3240873</a>
			<a href="#">3240701</a>	<a href="#">3240690</a>	



## Reducing adapters





Reducing adapters				Extension adapters		
	Thread	Brass, round	Brass, hexagonal		Thread	Brass
	M20/M16	<a href="#">1647611</a>			M16/M20	<a href="#">1647653</a>
	M25/M20	<a href="#">1647624</a>			M20/M25	<a href="#">1647666</a>
	M32/M25	<a href="#">1647637</a>			M25/M32	<a href="#">1647679</a>
	M40/M32	<a href="#">1647640</a>			M32/M40	<a href="#">1647682</a>
	Pg16/Pg13.5		<a href="#">1415216</a>		Pg13.5/Pg16	<a href="#">1415219</a>
	Pg21/Pg16		<a href="#">1415217</a>		Pg16/Pg21	<a href="#">1415220</a>
	Pg29/Pg21		<a href="#">1415218</a>		Pg21/Pg29	<a href="#">1415221</a>

Denotes **HeavyCORE** stock designation product

## Cable glands and adapters for NPT threads

Cable glands											
											
Thread	Cable diameter								Plastic		Metal
	IEC (mm)		IEC (in)		UL 514B (mm)		UL 514B (in)		Black	Gray	Nickel-plated brass
	Min.	Max.	Min.	Max.	Min.	Max.	Min.	Max.			
3/8"	5	10	0.20	0.39	6	10	0.24	0.39	1411156	1411152	1411182
1/2"	10	14	0.39	0.55	10	14	0.39	0.55	1411157	1411153	1411183
3/4"	13	18	0.51	0.71	13	18	0.51	0.71	1411158	1411154	1411184
1"	18	25	0.71	0.98	18	25	0.71	0.98	1411159	1411155	1411185

Counter nuts for direct panel mounting			
			
			
Thread	Plastic		Metal
	Black	Gray	Nickel-plated brass
3/8"	1411236	1411231	1416009
1/2"	1411237	1411233	1416010
3/4"	1411238	1411234	1416011
1"	1411239	1411235	1416012

Thread adapters					
					
Thread		EVO D/M1 housing	EVO B housing		NPT adapter
External	NPT internal	Plastic	Plastic	Metal	Metal
		Black	Black	Nickel-plated brass	Nickel-plated brass
M20	1/2"		1414251	1414264	1686847
Pg13.5					5540691
Pg16					
M25	3/4"	1411354	1414252	1414265	1686850
Pg21					5540714
M32	1"		1414253	1414266	1686863
Pg29					5540811
M40	1 1/4"		1414254	1414267	1687587
Pg36					5537387

 Denotes **HeavyCORE** stock designation product

# Protective covers

 Web code: #1953

	Description	Mounting	Locking	Fits Housing	Order no.	Type Description	IP Rating	Material
	Plug Cover	Lanyard	For Double Latch	B10	1346529	HC-B10-HCFD-PR-BK	IP66	Black PC
	Plug Cover	Lanyard	For Double Latch	B16	1346543	HC-B16-HCFD-PR-BK	IP66	Black PC
	Plug Cover	Lanyard	For Double Latch	B24	1346551	HC-B24-HCFD-PR-BK	IP66	Black PC
	Plug Cover	Lanyard	With Double Latch	B10	1346530	HC-B10-HCWD-PLR-BK	IP66	Black PC
	Plug Cover	Lanyard	With Double Latch	B16	1346544	HC-B16-HCWD-PLR-BK	IP66	Black PC
	Plug Cover	Lanyard	With Double Latch	B24	1346552	HC-B24-HCWD-PLR-BK	IP66	Black PC
	Plug Cover	Lanyard	With Double Latch	D50	1346553	HC-D50-HCWD-PLR-BK	IP66	Black PC
	Plug Cover	Lanyard	With Single Latch	B06	1346525	HC-B06-HCWS-PLR-BK	IP66	Black PC
	Plug Cover	Lanyard	With Single Latch	B10	1346528	HC-B10-HCWS-PLR-BK	IP66	Black PC
	Plug Cover	Lanyard	With Single Latch	B16	1346541	HC-B16-HCWS-PLR-BK	IP66	Black PC
	Plug Cover	Lanyard	With Single Latch	B24	1346550	HC-B24-HCWS-PLR-BK	IP66	Black PC
	Plug Cover	Lanyard	With Single Latch	D15	1346521	HC-D15-HCWS-PL-BK	IP66	Black PC
	Plug Cover	Lanyard	With Single Latch	D25	1346523	HC-D25-HCFS-PL-BK	IP66	Black PC
	Plug Cover	Lanyard	With Single Latch	EVO M1	1346557	HC-M1-HCWS-PLR-BK	IP66	Black PC
	Receptacle Cover	Lanyard	For Double Latch	B10	1346527	HC-B10-BCFD-P-BK	IP66	Black PC
	Receptacle Cover	Lanyard	For Double Latch	B16	1346539	HC-B16-BCFD-P-BK	IP66	Black PC
	Receptacle Cover	Lanyard	For Double Latch	B24	1346546	HC-B24-BCFD-P-BK	IP66	Black PC
	Receptacle Cover	Lanyard	For Double Latch	B32	1424850	HC-STA-B32-BCSFD-PL-BK	IP66	Black PA
	Receptacle Cover	Lanyard	For Double Latch	D50	1660193	HC-D 50-SD-FQ/FS	IP66	Gray PA
 	Receptacle Cover	Lanyard	For Single Latch	B06	1346524	HC-B06-BCFS-P-BK	IP66	Black PC
	Receptacle Cover	Lanyard	For Single Latch	B10	1346526	HC-B10-BCFS-P-BK	IP66	Black PC
	Receptacle Cover	Lanyard	For Single Latch	B16	1346537	HC-B16-BCFS-P-BK	IP66	Black PC
	Receptacle Cover	Lanyard	For Single Latch	B24	1346545	HC-B24-BCFS-P-BK	IP66	Black PC
	Receptacle Cover	Lanyard	For Single Latch	D15	1346518	HC-D15-BCFS-PR-BK	IP66	Black PC
	Receptacle Cover	Lanyard	For Single Latch	D25	1346522	HC-D25-BCFS-PR-BK	IP66	Black PC
	Receptacle Cover	Lanyard	For Single Latch	EVO M1	1346556	HC-M1-BCFS-P-BK	IP66	Black PC
	Receptacle Cover	Lanyard	For Single Latch	COM Pin Inserts COM Socket Inserts	1079396 1079397	HC-COM-BCFS-PL-BK HC-COM-BCFS-PLR-BK	IP66	Black PA Black PA
	Receptacle Cover	Hinged*	For Single Latch	B06	1407692	HC-B06-BC-HI-PLBK	IP65/66	Black PC
	Receptacle Cover	Hinged*	For Single Latch	B10	1407693	HC-B10-BC-HI-PLBK	IP65/66	Black PC
	Receptacle Cover	Hinged*	For Single Latch	B16	1407694	HC-B16-BC-HI-PLBK	IP65/66	Black PC
	Receptacle Cover	Hinged*	For Single Latch	B24	1407695	HC-B24-BC-HI-PLBK	IP65/66	Black PC
	Receptacle Cover	Hinged*	For Single Latch	D15	1414673	HC-D15-BC-HI-PLBK	IP65/66	Black PC
	Receptacle Cover	Hinged*	For Single Latch	D25	1414674	HC-D25-BC-HI-PLBK	IP65/66	Black PC
	Plug/Receptacle Cover	None	Snap-on	B06	1421100	HC-STA-B06-DC-PL	IP20	Transparent PA
	Plug/Receptacle Cover	None	Snap-on	B10	1421101	HC-STA-B10-DC-PL	IP20	Transparent PA
	Plug/Receptacle Cover	None	Snap-on	B16	1421102	HC-STA-B16-DC-PL	IP20	Transparent PA
	Plug/Receptacle Cover	None	Snap-on	B24	1421103	HC-STA-B24-DC-PL	IP20	Transparent PA

\* Only for panel mounting and surface mounting bases.

 Denotes **HeavyCORE** stock designation product







# Connector kits

**i** Web code: #0523

	Connection	Connection cross-section IEC // UL	Rated current IEC // UL	Rated voltage IEC // UL	Cable OD	Cover	Inlet	Number of positions	Order no.	
<b>D7 plastic connector kits</b>										
	Push-in (PT)	0.14 mm <sup>2</sup> ... 1.5 mm <sup>2</sup> // AWG 16	16 A // 17.5 A	230 / 400 V // 600 V	4-10 mm	No	Side	3+PE	1424447	
							Top		1424445	
							Side	4+PE	1424448	
							Top		1424446	
<b>D7 metal connector kits</b>										
	Push-in (PT)	0.14 mm <sup>2</sup> ... 1.5 mm <sup>2</sup> // AWG 16	16 A // 17.5 A	230 / 400 V // 600 V	6-12 mm	No	Side	3+PE	1424451	
							Top	3+PE	1424449	
							Side	4+PE	1424452	
							Top	4+PE	1424450	
<b>EVO plastic D15 and D25 connector kits</b>										
	Push-in (PT)	0.14 mm <sup>2</sup> ...2.5 mm <sup>2</sup> // AWG 14	16 A // 17 A	250 V // 600 V	7-13 mm	No	Top/ Side	10+PE	1424454	
									No	1424453
	Screw		16 A // 19 A						Yes	1411357
									No	1411356
	Push-in (PT)		16 A // 17 A		9-17 mm	No		16+PE	Yes	1424460
									No	1424459
	Screw		16 A // 19 A						Yes	1411359
									No	1411358
<b>STANDARD metal D15 and D25 connector kits</b>										
	Push-in (PT)	0.14 mm <sup>2</sup> ...2.5 mm <sup>2</sup> // AWG 14	16 A // 17 A	250 V // 600 V	6-12 mm	No	Side Top	10+PE	1424458	
									Yes	1424456
									Side	1424457
									Top	1424455
					11-17 mm	No		16+PE	Yes	1424464
									Top	1424462
									Side	1424463
									Top	1424461

# Connector kits

**i** Web code: #0523

	Connection	Connection cross-section IEC // UL	Rated current IEC // UL	Rated voltage IEC // UL	Cable OD	Cover	Inlet	Number of positions	Order no.						
<b>Single-latch EVO B plastic connector kits</b>															
	Push-in (PT)	0.14 mm <sup>2</sup> ... 2.5 mm <sup>2</sup> // AWG 14	16 A // 13 A	500 V // 600 V	7-13 mm	Yes	Top/ Side	6+PE	1407710						
					9-17 mm			10+PE	1408791						
					9-17 mm			16+PE	1408793						
					11-21 mm			24+PE	1408794						
<b>Double-latch EVO B plastic connector kits</b>															
	Push-in (PT)	0.14 mm <sup>2</sup> ... 2.5 mm <sup>2</sup> // AWG 14	16 A // 13 A	500 V // 600 V	6-12 mm	No	Top/ Side	10+PE	1407711						
								16+PE	1407712						
								24+PE	1407713						
<b>Single-latch EVO B metal connector kits</b>															
	Push-in (PT)	0.14 mm <sup>2</sup> ... 2.5 mm <sup>2</sup> // AWG 14	16 A // 13 A	500 V // 600 V	9-13 mm	Yes	Top/ Side	6+PE	1411487						
					11-16 mm			10+PE	1411491						
					11-16 mm			16+PE	1411492						
					14-21 mm			24+PE	1411493						
<b>Double-latch EVO B metal connector kits</b>															
	Push-in (PT)	0.14 mm <sup>2</sup> ... 2.5 mm <sup>2</sup> // AWG 14	16 A // 13 A	500 V // 600 V	11-16 mm	No	Top/ Side	10+PE	1411488						
					11-16 mm			16+PE	1411489						
					14-21 mm			24+PE	1411490						
<b>Single-latch STANDARD B metal connector kits</b>															
	Push-in (PT)	0.14 mm <sup>2</sup> ... 2.5 mm <sup>2</sup> // AWG 14	16 A // 13 A	500 V // 600 V	6-12 mm	Yes	Side	6+PE	1416353						
							Top		1416344						
							11-17 mm	Side	10+PE	1416354					
								Top		1416345					
							15-21 mm	Side	16+PE	1416356					
								Top		1416348					
					Side			24+PE	1416358						
					Top				1416351						
					<b>Double-latch STANDARD B metal connector kits</b>										
							Push-in (PT)	0.14 mm <sup>2</sup> ... 2.5 mm <sup>2</sup> // AWG 14	16 A // 13 A	500 V // 600 V	11-17 mm	No	Side	10+PE	1416355
													Top		1416346
													15-21 mm	Side	16+PE
Top	1416349														
15-21 mm	Side	24+PE	1416359												
	Top		1416352												



## Additional information

### Accessories

You will find a comprehensive listing of accessories and replacement parts for advanced installation options and repairs for our complete HEAVYCON product range under:

**i** Web code: #0521

You will find our wide range of crimping tool and ferrule products under:

**i** Web code: #0544

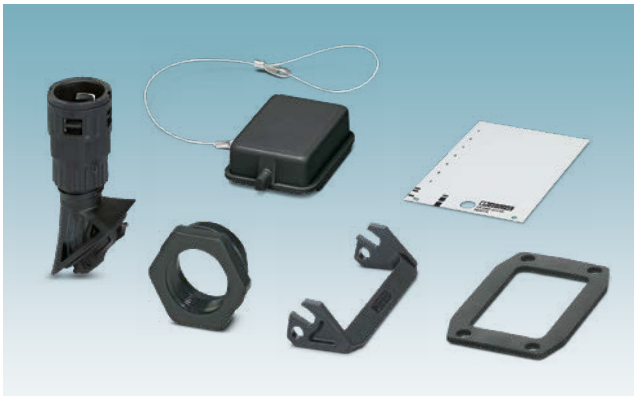

### EPLAN data including 3D models

The latest EPLAN data in the format for EPLAN Electric P8 Version 2.x is available on our website under Service and Support / Downloads / EPLAN-P8-Data Manager. You will receive the product data in XML format for import into the product management system, product photos, as well as 3D models, and macros. This data is also available in the EPLAN Data Portal.

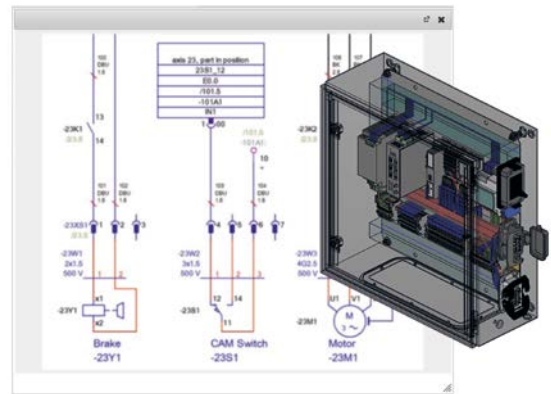

### CES cable entry system

Cables can be clearly and systematically routed into the control cabinet with the CES modular cable entry system. Flexibly combinable cable seals can be mounted and replaced quickly. The cable seals are available in various shapes and diameters. They are particularly robust, and provide a reliable seal with protection class IP54.

**i** Web code: #0570



### DIN rail mounting frames

The new HC-CIF DIN rail mounting frames can be used to install pre-assembled contact inserts quickly and easily directly on the DIN rail in the control cabinet. Made from robust high-performance plastic, the frames are stable, very light, and also accommodate plastic sleeve housings from the HEAVYCON EVO B series of connectors.

**i** Web code: #1581



## Solution Center value-add services needs

### Modified cable outlets

We offer connectors with cable outlets that are tailor-made to your requirements by modifying our standard housings.



### Customized sets

If you require the same connector configuration for series machines or service tasks, we will gladly put together the matching set for you under one order number.

**i** Web code: #0523



### Assembled housings

We provide sleeve housings and panel mounting bases for heavy-duty connectors assembled and wired in accordance with your specifications. Simply mount and wire in the cabinet – and your interface is ready.



### Clearly marked

We mark in accordance with your requirements – whether cable or wire marking for different mounting types or directly printed cables and brand labeling.









# LIMITED LIFETIME WARRANTY

BUILD WITH CONFIDENCE

## Build with confidence

Our Limited Lifetime Warranty is our promise to you that the products you install in your control cabinets are built to last. In industry and infrastructure, we stand with you. Simply register and relax. Isn't it time you trusted Phoenix Contact to build your cabinet confidence?

Register today at: [www.phoenixcontact.com/LLW](http://www.phoenixcontact.com/LLW)

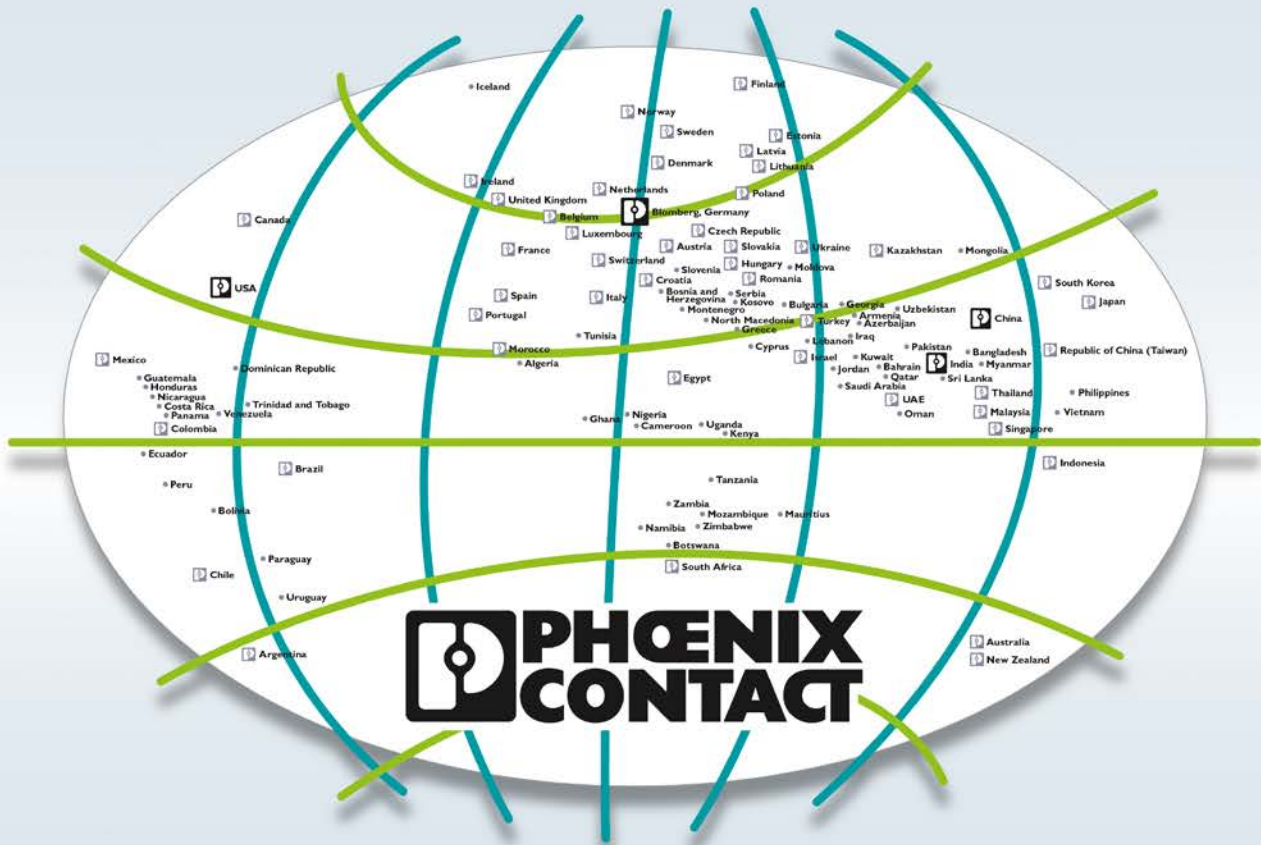

## Open communication with customers and partners worldwide

Phoenix Contact is a global market leader based in Germany. We are known for producing future-oriented products and solutions for the electrification, networking, and automation of all sectors of the economy and infrastructure. With a global network reaching across more than 100 countries with over 22,000 employees, we maintain close relationships with our customers, something we believe is essential for our common success.

Our wide range of innovative products makes it easy for our customers to implement the latest technology in a variety of applications and industries. This especially applies to the target markets of energy, infrastructure, industry, and mobility.

You can find your local partner at  
[phoenixcontact.com](http://phoenixcontact.com)