



PLCnext Engineer
Engineering Software

Ecosystem & PLCnext Store

PLCnext Technology 
Designed by PHOENIX CONTACT

The Open Ecosystem for Limitless Automation

PLCnext Technology 
enhance your automation thinking

PLCnext Control



Open Control Platform

PLCs in various performance classes including PLCnext Runtime System and accessories for PLCnext Technology

PLCnext Engineer



Engineering Software

Engineering tool for commissioning, configuring, and programming PLCnext Controls

PLCnext Store



Software Store for Automation

Apps for functional extension of PLCnext Control and PLCnext Engineer

PLCnext Community



User Collaboration & Resources

Information, support, and helpful resources about PLCnext Technology including FAQs, forums, tutorials and a GitHub presence

The scope of PLCnext technology as an umbrella brand ranges from technology, equipment, tools and software to technical systems and processes. Source: <https://de.wikipedia.org/wiki/Technologie>



PLCnext Engineer

PLCnext Technology 
Designed by PHOENIX CONTACT

PLCnext Technology Configuration and Engineering

Fast and flexible configuration

- C-Code, Simulink models, function components, IEC61131-3, Safety, HMI

Extendable

- By licensed add-ins like the Viewer for Simulink

Easy handling

- Intuitive user interface
- Clear structures

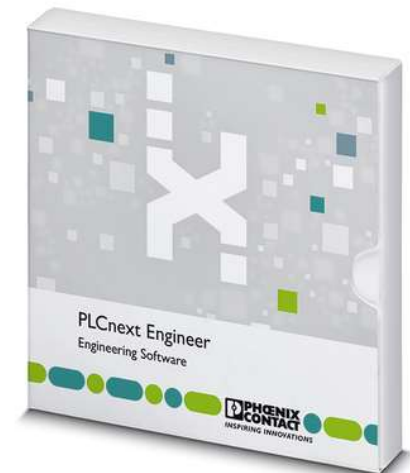

The software for configuration and engineering

PLCnext Engineer

Complete Integrated System

PLCnext Technology 
Designed by PHOENIX CONTACT



PLCnext Engineer

Information Architecture

PLCnext Technology 
Designed by PHOENIX CONTACT

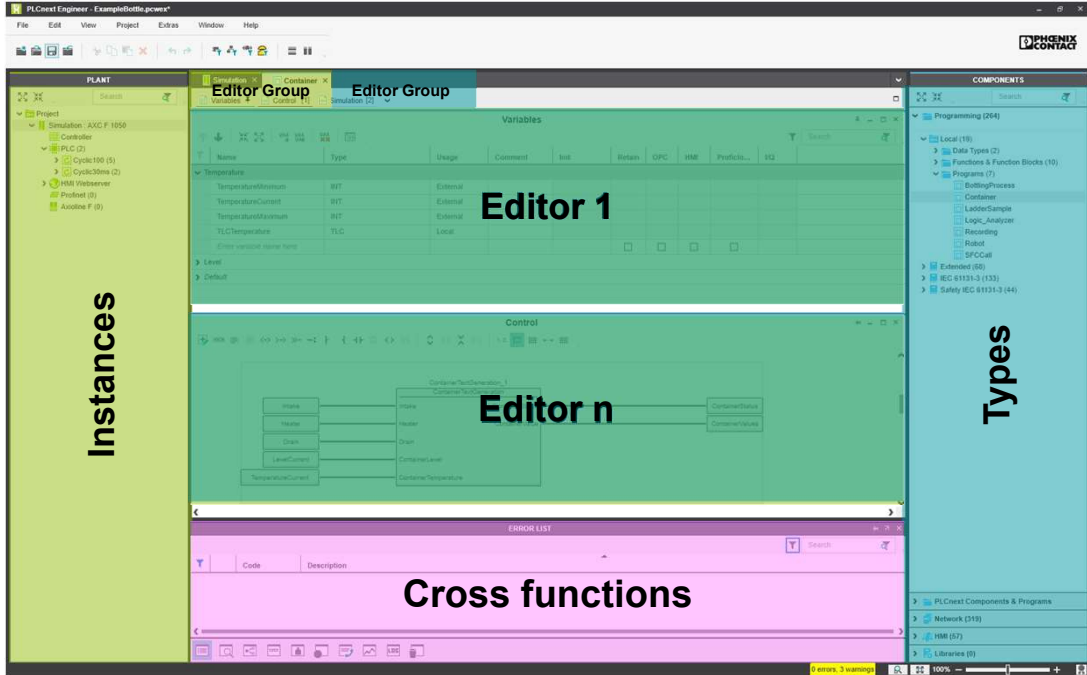

The screenshot shows the PLCnext Engineer software interface. On the left, a tree view labeled "Instances" shows a project structure. The main workspace is divided into two "Editor Group" windows: "Editor 1" displays a "Variables" table, and "Editor n" displays a "Control" diagram. On the right, a "COMPONENTS" panel labeled "Types" lists various programming elements. At the bottom, an "ERROR LIST" panel labeled "Cross functions" is visible. The interface includes a menu bar, a toolbar, and a status bar at the bottom.

Name	Type	Usage	Comment	Unit	Bitwise	CPC	HW	Product...	UD
TemperaturePressure	INT	External							
TemperatureCurrent	INT	External							
TemperatureMaximum	INT	External							
TLCTemperature	TLC	Local							

The User Interface – Plant Area

- Instance trees
 - Programs
 - Visualization pages
 - IO configuration
- Task configuration
- Controller configuration
- Central Cockpit
 - Application control
 - Device information

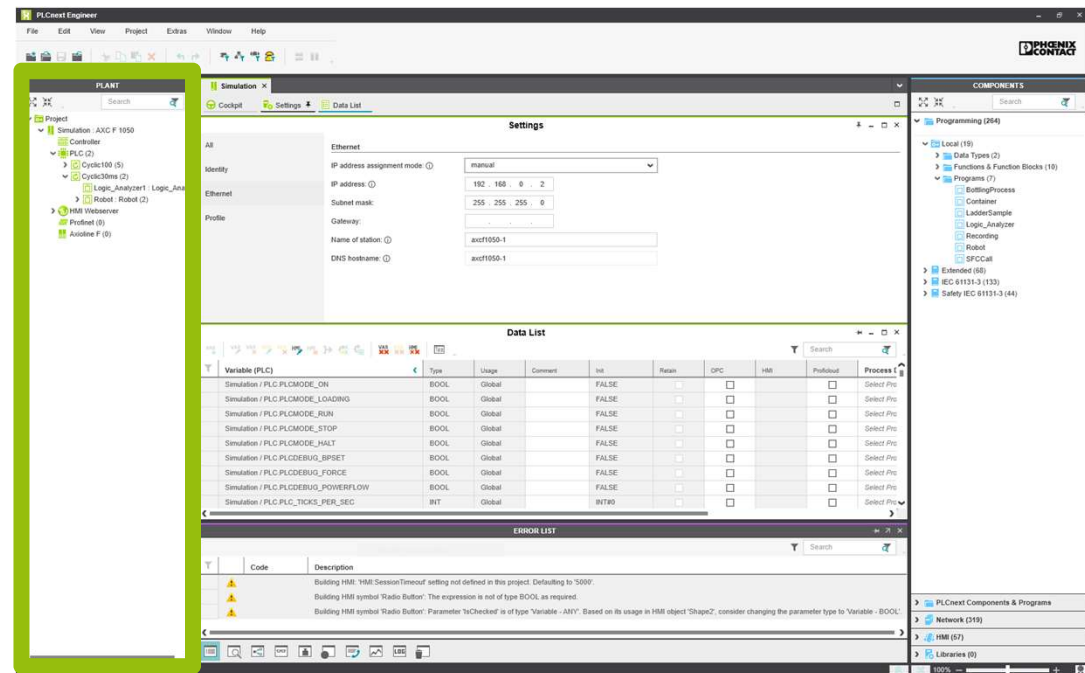

The User Interface – Component Area

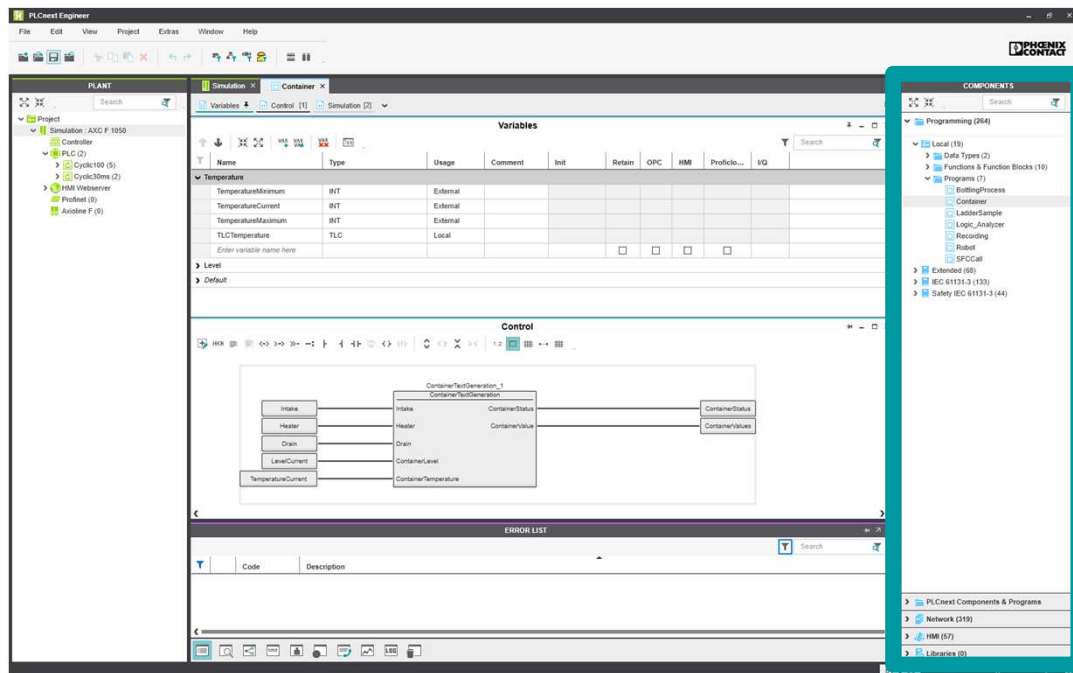

- IEC 61131-3
 - Programs, functions and function blocks
 - Data types
- Device catalogue
 - Import of devices
- Visualization symbol library
- References to libraries

The User Interface – Editor Area

- Central editing
- Split view windows
- Full screen windows
- Arrange multiple editor windows
- Type or instance Editor color highlighted

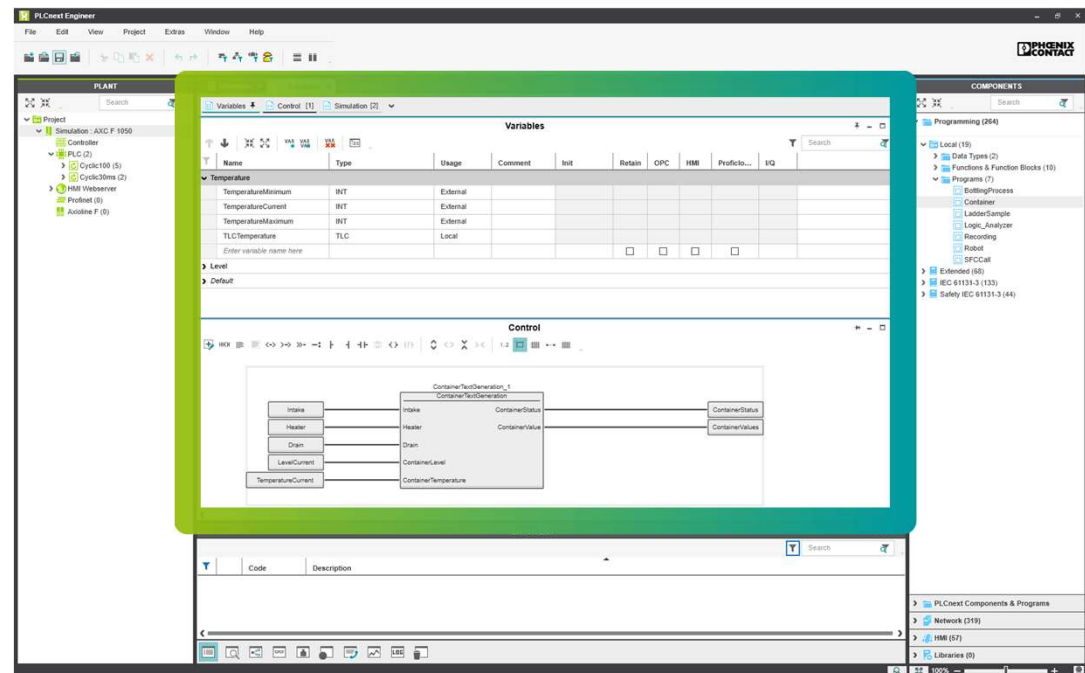

PLCnext Engineer

The User Interface – Cross Function Area

- Undockable windows
- Message window
- Global find & replace
- Cross references
- Watch window
- Debug information
- Logic analyzer
- Logging
- Recycle bin

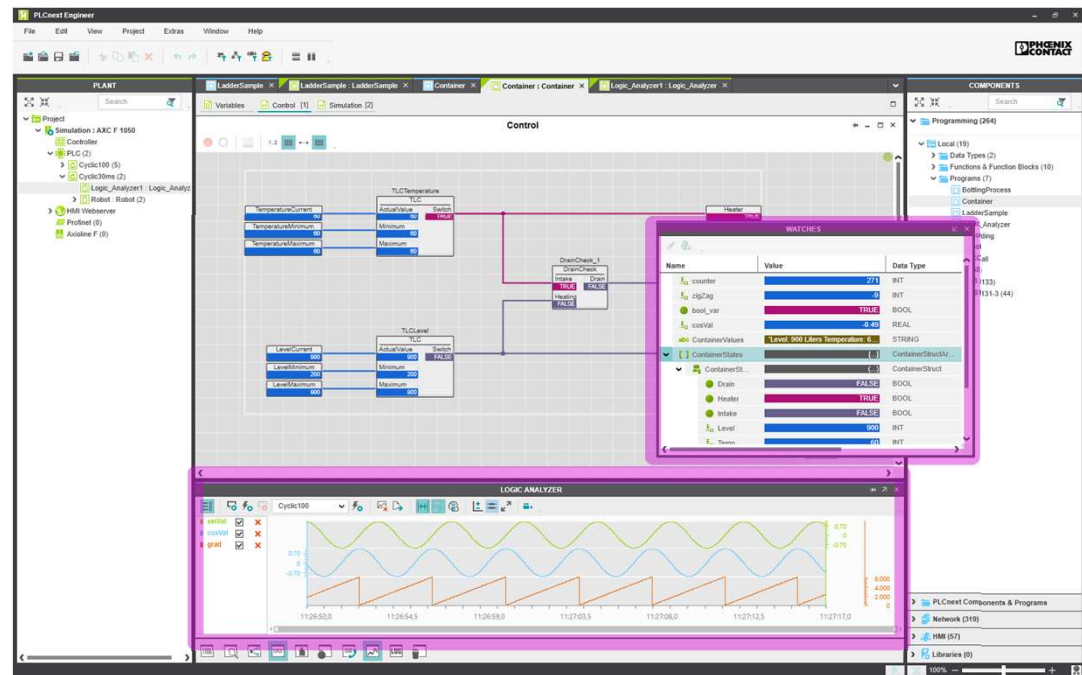

The User Interface – Menu Bar



- **Standard functions**

Windows conform

- Project handling
- Cut / copy / paste objects
- Delete objects
- Undo / redo

- **System filter**

Show or hide information

- Programming objects
- Network related objects
- HMI related objects
- Safety related objects

- **Split Screen function**

Arrange two editor groups

- Horizontal split mode
- Vertical split mode

IEC 61131-3 Editors

- Graphical programming
 - Function Block Diagram (FBD)
 - Ladder (LD)
 - Network based or free graphical editor
 - Methods on function blocks in graphical languages

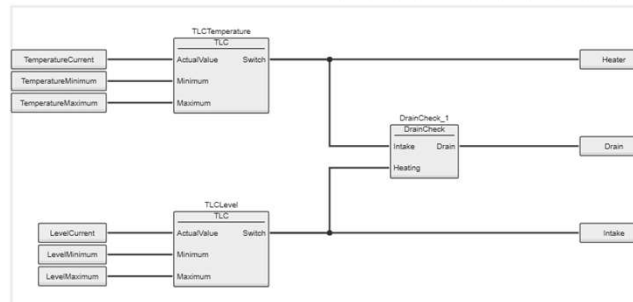
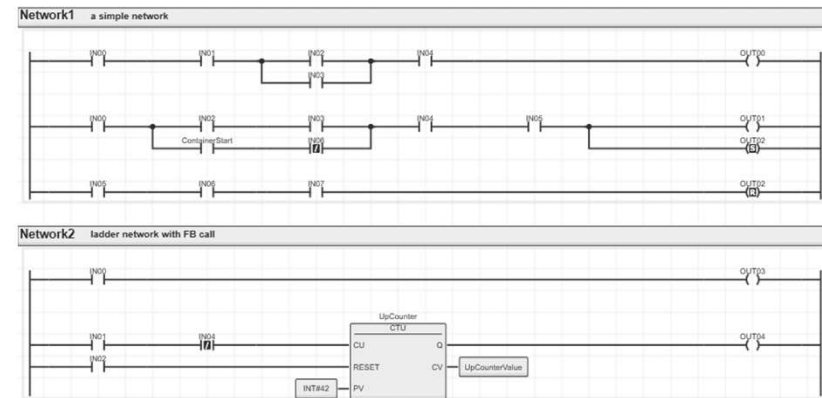

IEC 61131-3 Editors

- **Structured Text (ST)**
 - Syntax highlighting
 - Autofill assistant
 - IntelliSense function
 - Folding of code segments
 - RolePicker assistant
 - Templates for statements
 - Methods on function blocks

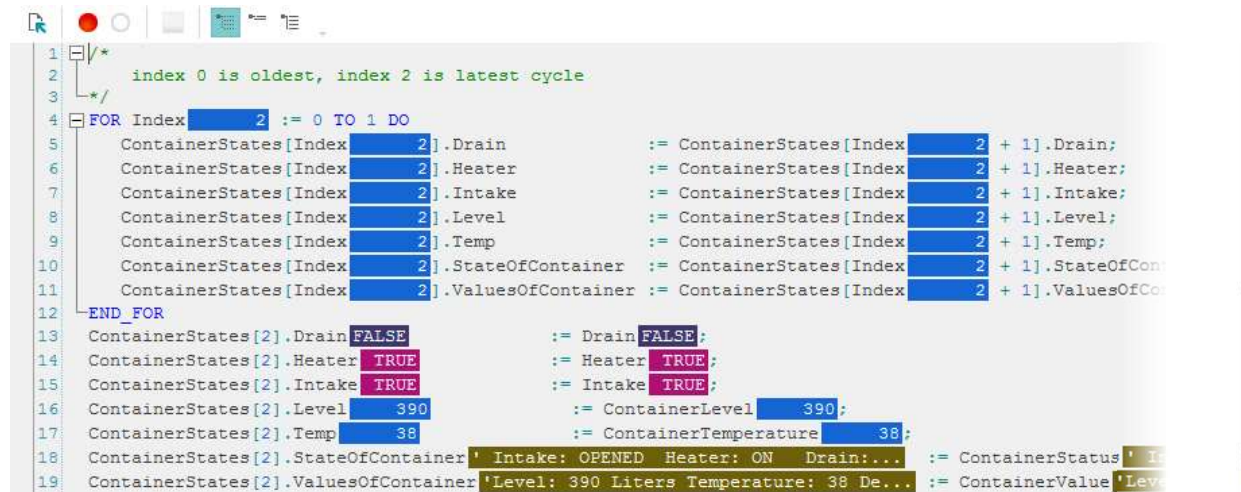

```

1  /*
2  |   index 0 is oldest, index 2 is latest cycle
3  | */
4  FOR Index := 0 TO 1 DO
5      ContainerStates[Index].Drain := ContainerStates[Index + 1].Drain;
6      ContainerStates[Index].Heater := ContainerStates[Index + 1].Heater;
7      ContainerStates[Index].Intake := ContainerStates[Index + 1].Intake;
8      ContainerStates[Index].Level := ContainerStates[Index + 1].Level;
9      ContainerStates[Index].Temp := ContainerStates[Index + 1].Temp;
10     ContainerStates[Index].StateOfContainer := ContainerStates[Index + 1].StateOfContainer;
11     ContainerStates[Index].ValuesOfContainer := ContainerStates[Index + 1].ValuesOfContainer;
12 END_FOR
13 ContainerStates[2].Drain := Drain;
14 ContainerStates[2].Heater := Heater;
15 ContainerStates[2].Intake := Intake;
16 ContainerStates[2].Level := ContainerLevel;
17 ContainerStates[2].Temp := ContainerTemperature;
18 ContainerStates[2].StateOfContainer := ContainerStatus;
19 ContainerStates[2].ValuesOfContainer := ContainerValue;
    
```

PLCnext Engineer

Integrated Visualization Editor

- **Deeply integrated**
 - Based on central handling
- **Scalable**
 - From small scale controllers to IPCs
- **No client installation**
 - Modern web browser
- **Technology-neutral**
 - Screens are stored in neutral format
- **Lightweight**
 - Low resource demands on PLC

PLCnext Technology 
Designed by PHOENIX CONTACT



PLCnext Engineer

Integrated Visualization Editor

- Definition of single line expressions
 - IntelliSense completions
 - Semantic analysis
- Integrated online mode
 - Everything in one environment

PLCnext Technology 
Designed by PHOENIX CONTACT



Integrated Visualization Editor

- Navigation Editor
 - Graphical definition of basic navigation structures (swipe up, right, left, or down)
 - Easy assembly of navigation structures through drag & drop
 - Content of a page is displayed within thumbnails
- Consistent library handling
 - Easy to use symbol editor



PLCnext Engineer

Integrated Visualization Editor

- User Management
 - Access right configuration of objects
 - Management via IEC 61131-3 function blocks possible
 - Authentication object template

PLCnext Technology 
Designed by PHOENIX CONTACT



PLCnext Engineer

Visualization Runtime Concept

PLCnext Technology 
Designed by PHOENIX CONTACT

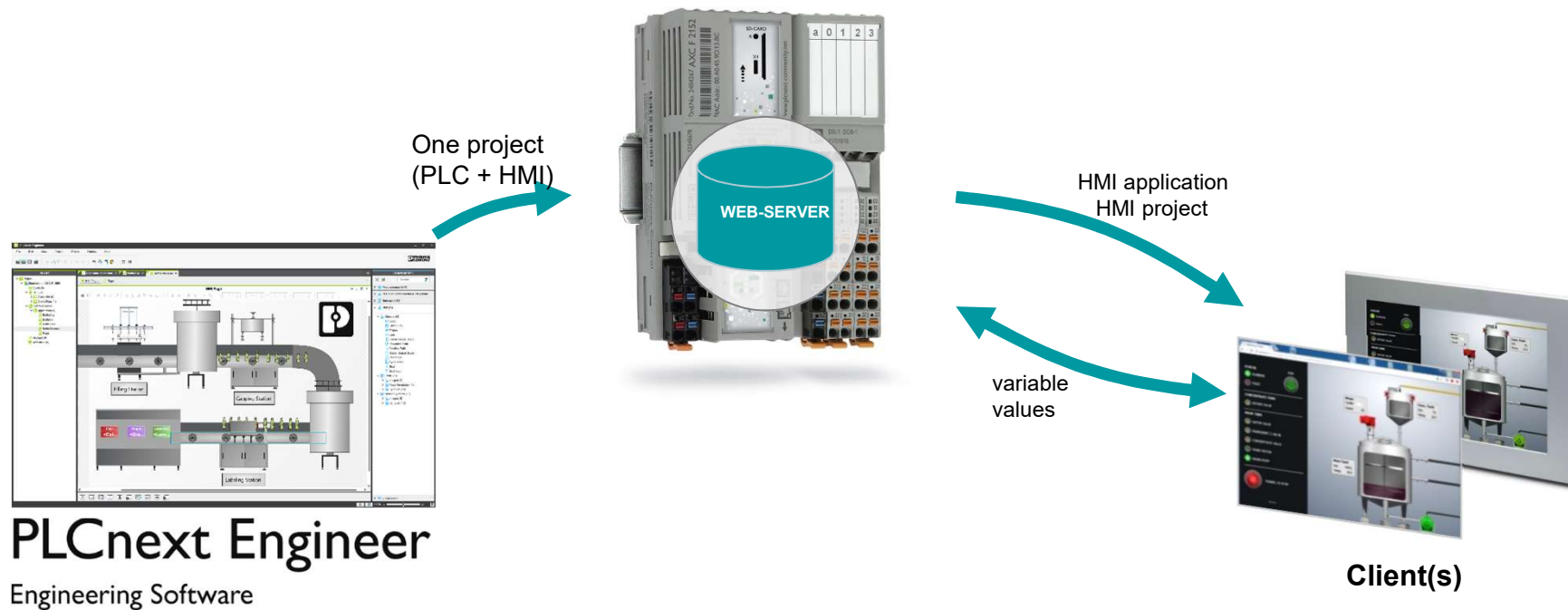

Usability Features Examples

InPlace Actions

- Placed directly beside graphical objects
- Offer the most important functions

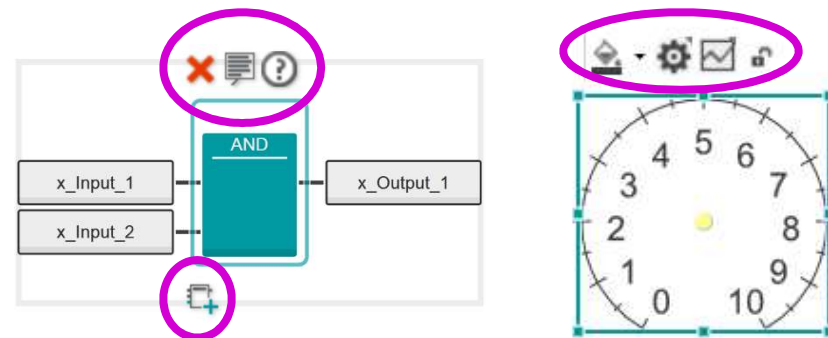
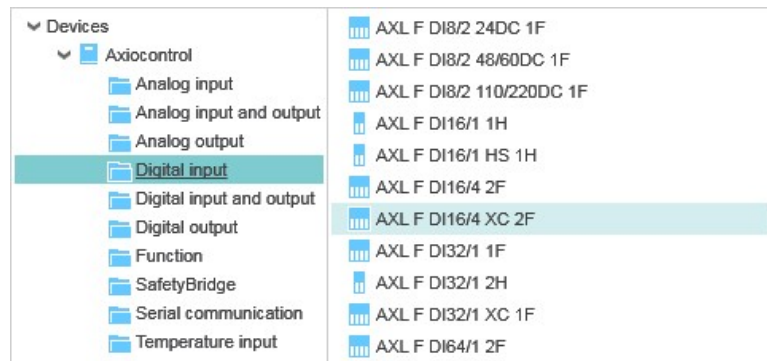

RolePicker

- Offers only usable objects
 - Smart filter mechanism
 - Pre-selection in categorized folders
- Shown in hardware selection
 - Shown in process data assignment, ...

Fast Navigation through Graphical Code

- Overview windows for graphical code editors
 - Switch off and on by button
 - Zoom in and out in overview window

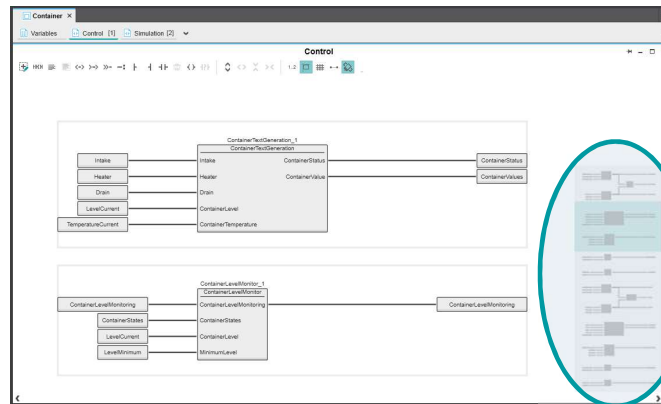

Commissioning and Troubleshooting



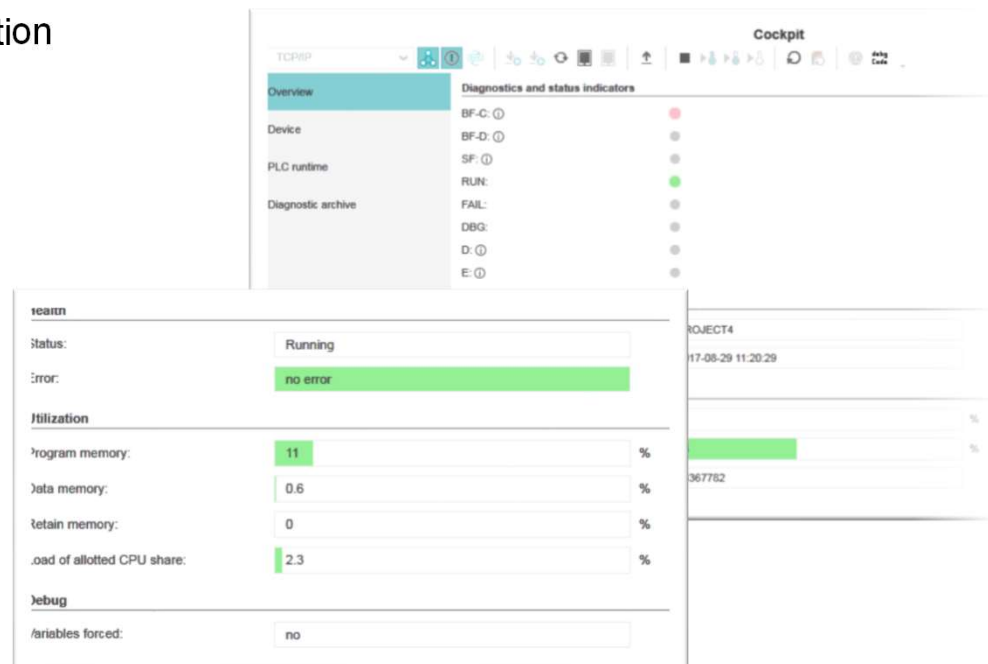





- Central Cockpit with application information
 - Send and control the application
 - Get controller status
 - Get application status
 - Diagnostic archive
- Logic analyzer
- Watch windows
- Breakpoints / single step
- Online debugging in libraries
- Instance / Function debugging
- Execution value









Network Configuration

- Local bus configuration of controller
 - Configuration with RolePicker
 - Read in connected devices
- Profinet IO configuration
 - Complete device catalogue
 - Import devices via GSDML standard
 - Discover and connect online devices
 - Read in online devices

Online Devices

LAN-Verbindung 3 Realtek RTL8168D/8111D-Famil...        

6 entries

Name of station (Project) >	Status	Name of station (Online) <	Function	Location
il-pn-bk-di8-do4-2bx-1		Select online device here		
il-pn-bk-di8-do4-2scrj-1		Select online device here		
axl-f-bk-pn-xc-1		Select online device here		
axl-f-bk-pn-tps-1		Select online device here		
axl-f-bk-pn-scrj-1		Select online device here		
axl-f-bk-pn-1		axl-f-bk-pn-1		

PLCnext Engineer

Profinet Configuration

Most important settings are now available in one table and will be improved for further settings

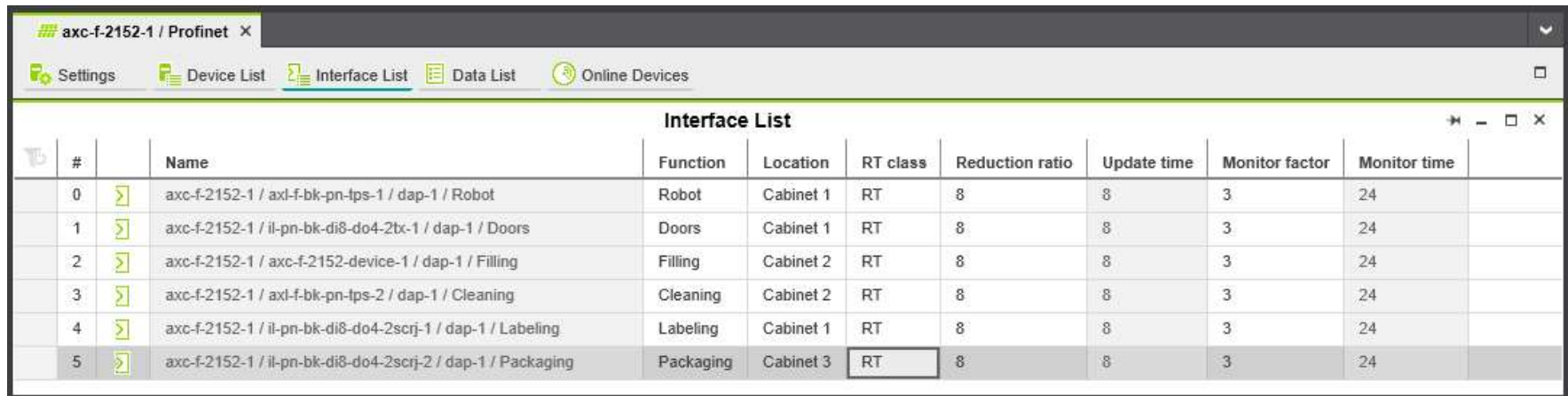

#	Name	Function	Location	RT class	Reduction ratio	Update time	Monitor factor	Monitor time
0	axc-f-2152-1 / axl-f-bk-pn-lps-1 / dap-1 / Robot	Robot	Cabinet 1	RT	8	8	3	24
1	axc-f-2152-1 / il-pn-bk-di8-do4-2tx-1 / dap-1 / Doors	Doors	Cabinet 1	RT	8	8	3	24
2	axc-f-2152-1 / axc-f-2152-device-1 / dap-1 / Filling	Filling	Cabinet 2	RT	8	8	3	24
3	axc-f-2152-1 / axl-f-bk-pn-lps-2 / dap-1 / Cleaning	Cleaning	Cabinet 2	RT	8	8	3	24
4	axc-f-2152-1 / il-pn-bk-di8-do4-2scrj-1 / dap-1 / Labeling	Labeling	Cabinet 1	RT	8	8	3	24
5	axc-f-2152-1 / il-pn-bk-di8-do4-2scrj-2 / dap-1 / Packaging	Packaging	Cabinet 3	RT	8	8	3	24

Project Documentation

- Function / location / reference instead of BMK
- Printout project:
 - Code
 - Data Lists
 - HMI screens and objects
 - Safety application

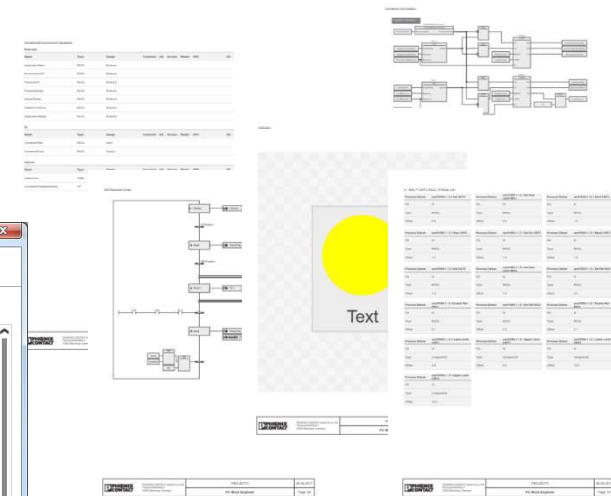
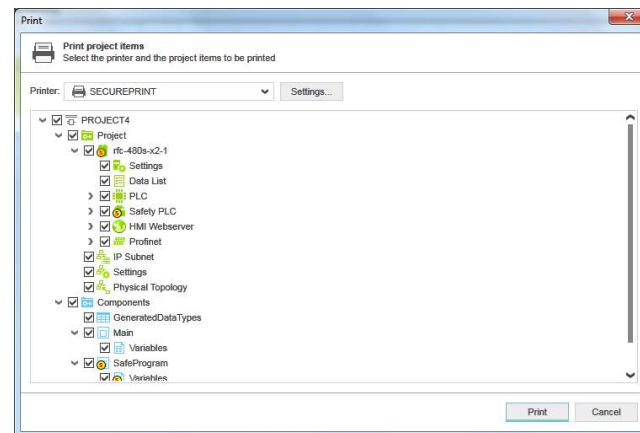

Device Replacement

- Replace device type at any level
 - Controller
 - Profinet device, module, submodule
 - Axioline F device,
 - IB Inline device
- Keep data of existing object
 - Subsystem
 - Process data connections,
 - Function & Location,
 - Parameters, Settings, Programs, ESM, HMI, ...

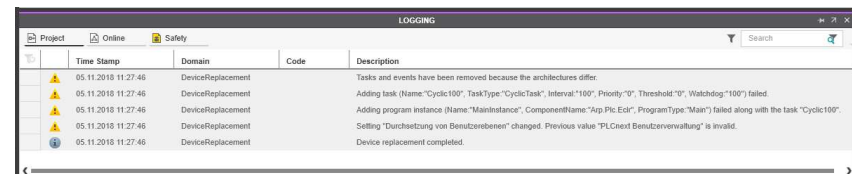
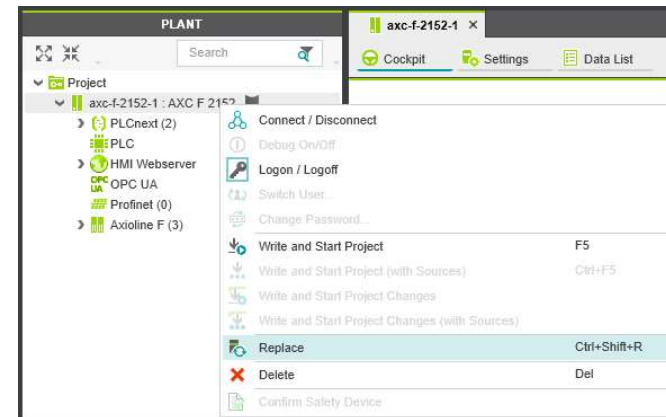

User Library Management

- One standard library release function for:
 - Standard IEC 61131-3 Code
 - Safety code
 - HMI symbols
 - Devices
- Additional features
 - *.chm Help integration for user POU's
 - Localized help
 - Library description via tooltip
 - PLCnext component libraries for MultiTargets

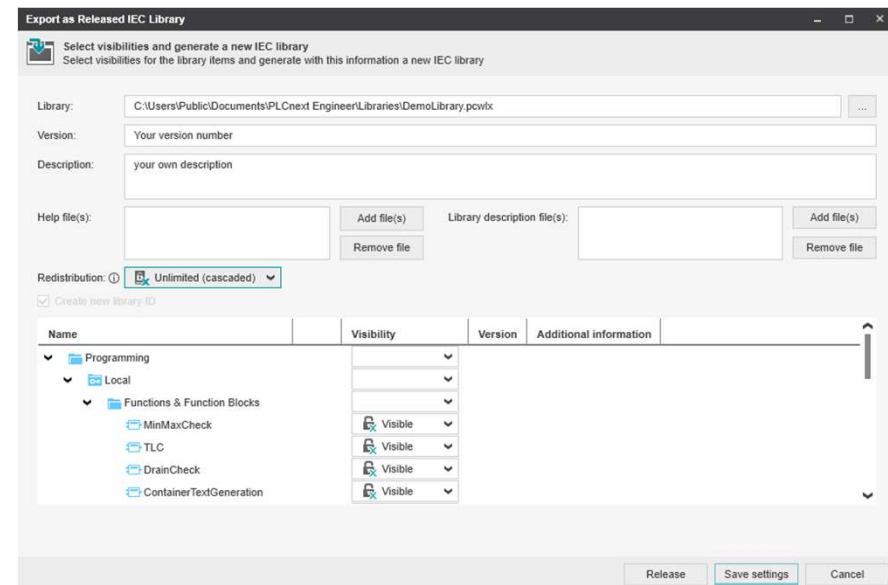

Project Statistics Page

- First stage of a project statistic:
 - Project limits overview
 - POU usage in detail
 - Check of limits beforehand

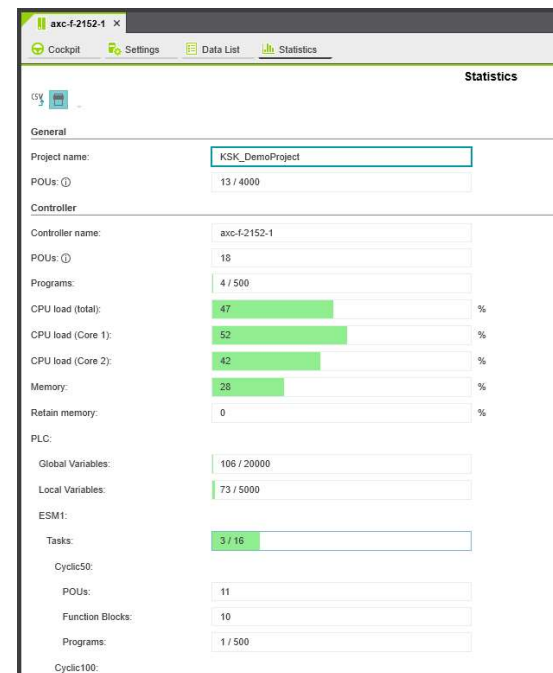

PLCnext Engineer

Logic Analyzer

The **Logic Analyzer** function of PLCnext Engineer can now also be used with PLCnext Controls.

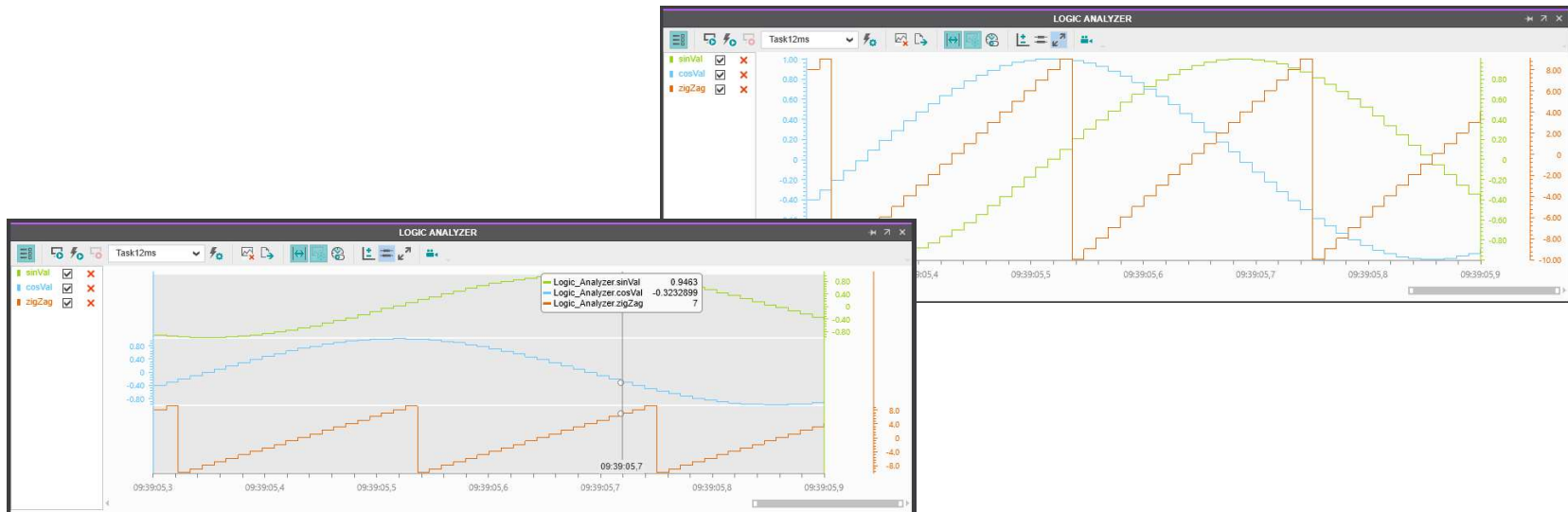

Extended Qualifiers in IEC 61131-3 Variable Names

- Option to switch on
 - Open the 'Compiler > IEC Compiler Settings' section in the Options dialog, activate the 'Allows extended identifiers' checkbox confirm.
- Rules for using
 - at least contain one alphabetical character.
 - not start with multiple underscores.
 - not start like a constant with `<literal_prefix>#` or keywords.
 - `/ * - + < >` are **regular operators** in textual programming languages, separated them by whitespaces.

Find Variable Access faster

- X-Reference windows for the whole project
 - Additional „kind“ attribute
 - More HMI data
 - Symbol instances
 - Tags
 - Extended filter
- Local X-References at each variable in context menu

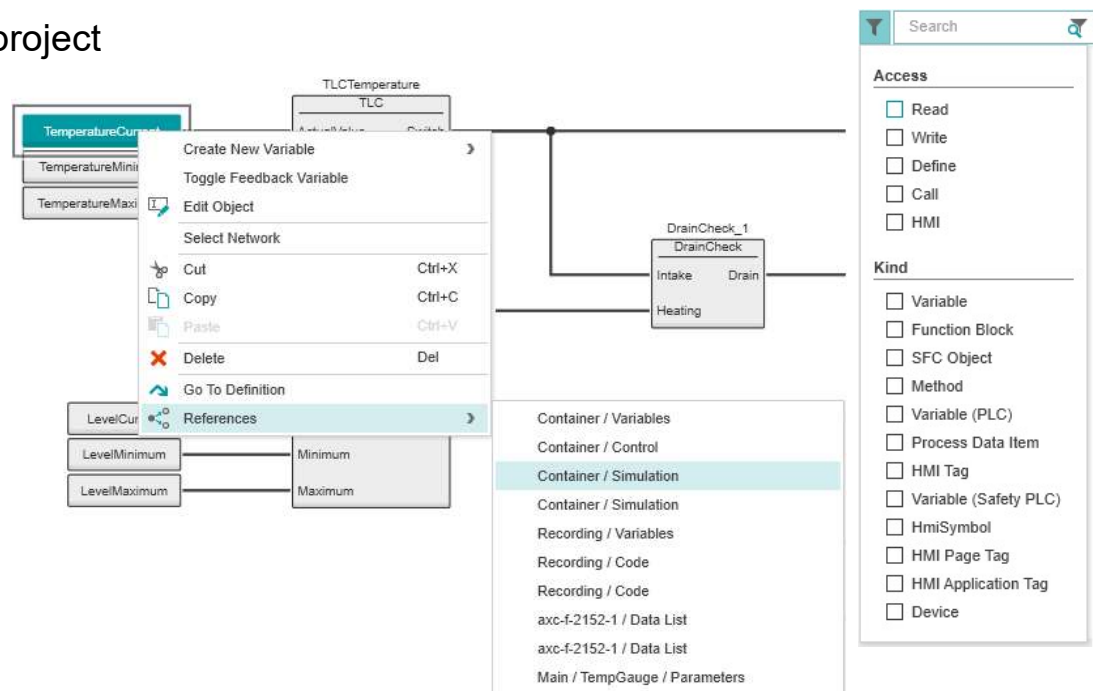

Documentation

- Property editor for project and HMI symbols
 - Import/Export as HTML
 - Version table
 - Enhanced text properties
 - Insert tables
 - Insert pictures

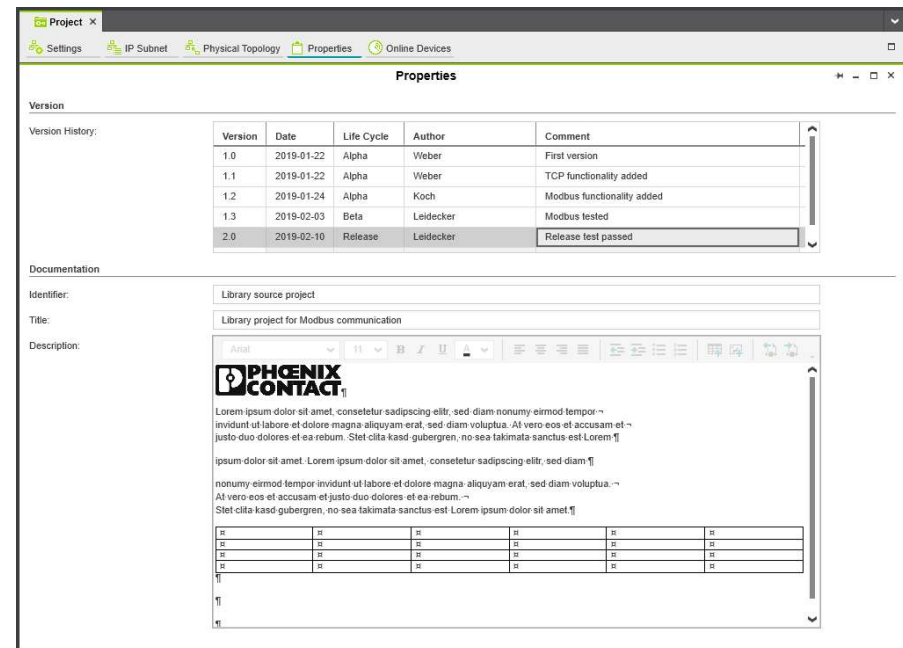

License Structure

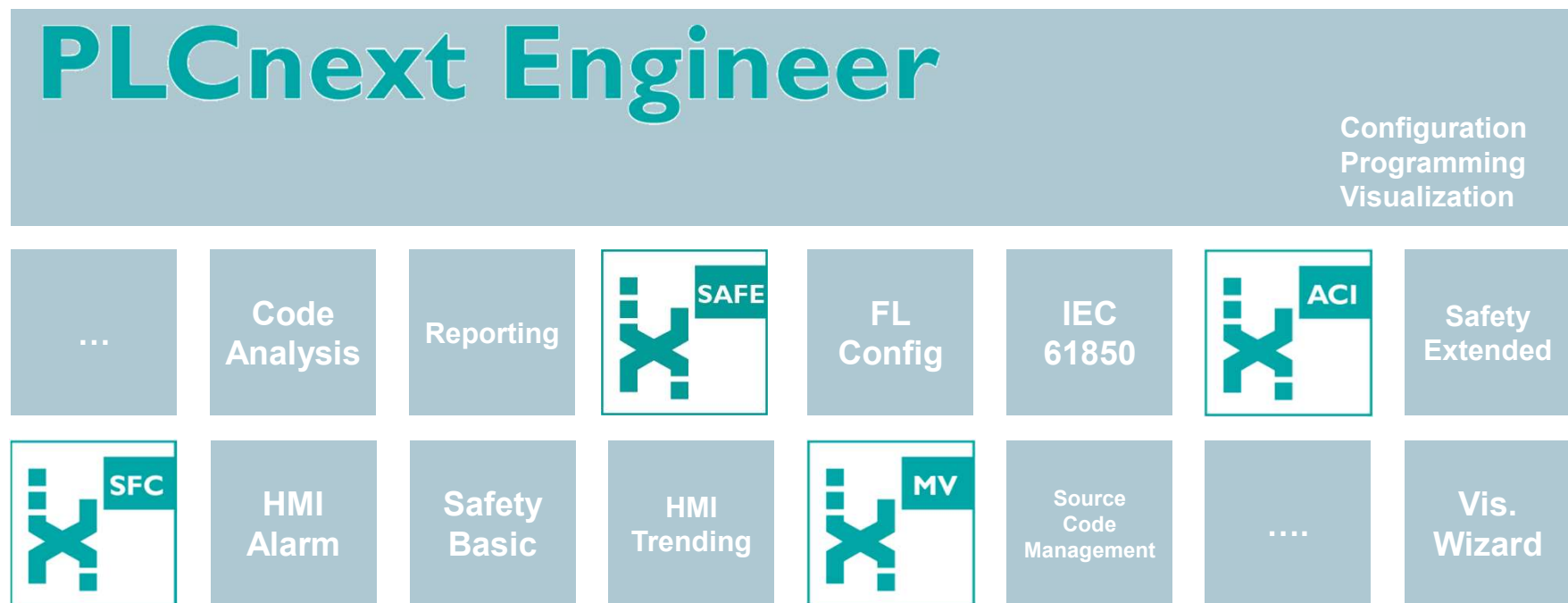

License Structure

Free of charge

PLCnext Engineer

Configuration
Programming
Visualization

Licensed AddIns

...	Code Analysis	Reporting	 SAFE	FL Config	IEC 61850	 ACI	Safety Extended
 SFC	HMI Alarm	Safety Basic	HMI Trending	 MV	Source Code Management	Vis. Wizard

32  Icon = available Add-In

 No icon = Idea about future Add-Ins

Sequential Function Chart – SFC



- Represented as a function block
- Automatic generated TypeInfo and StateInfo structure
- Error handling
- Directly connected transitions
- Transitions in separate worksheets (FBD, ST, LD)
- Operation modes:
Automatic, Manual Step, Halted

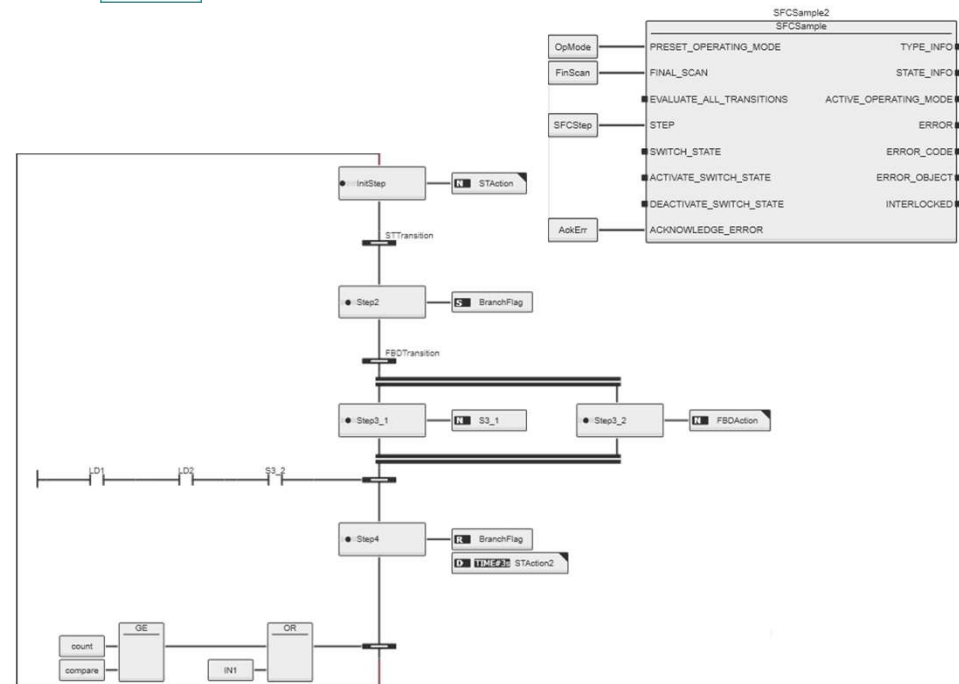



Sequential Function Chart – SFC

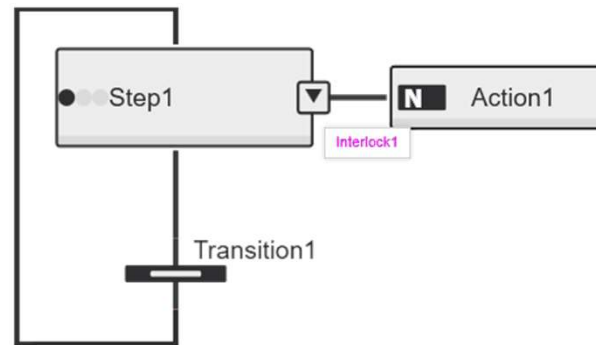
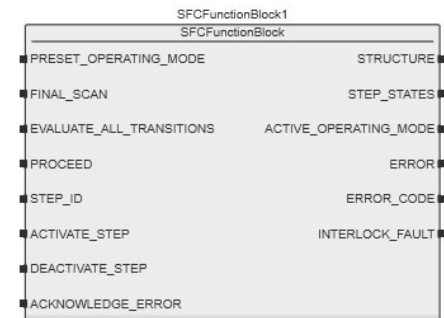
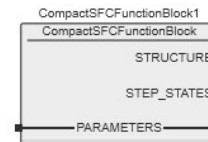

- Compact SFC
- STEP Interlock
can be used to control the execution of actions associated to a step
- Pre-Execute worksheet
- Post-Execute worksheet



-  Add Action
-  Add Transition
-  Add Interlock
-  Add PreExecute
-  Add PostExecute

PLCnext Engineer

Functional Safety Programming



PLCnext Technology 
Designed by PHOENIX CONTACT

Fully integrated Safety Programming

- TÜV Rheinland certified according to IEC 61508
- Editor with common behavior as known from standard FBD or LD editor
- Low Variability Language support
- Network granular CRC checksums
- PROFIsafe Support

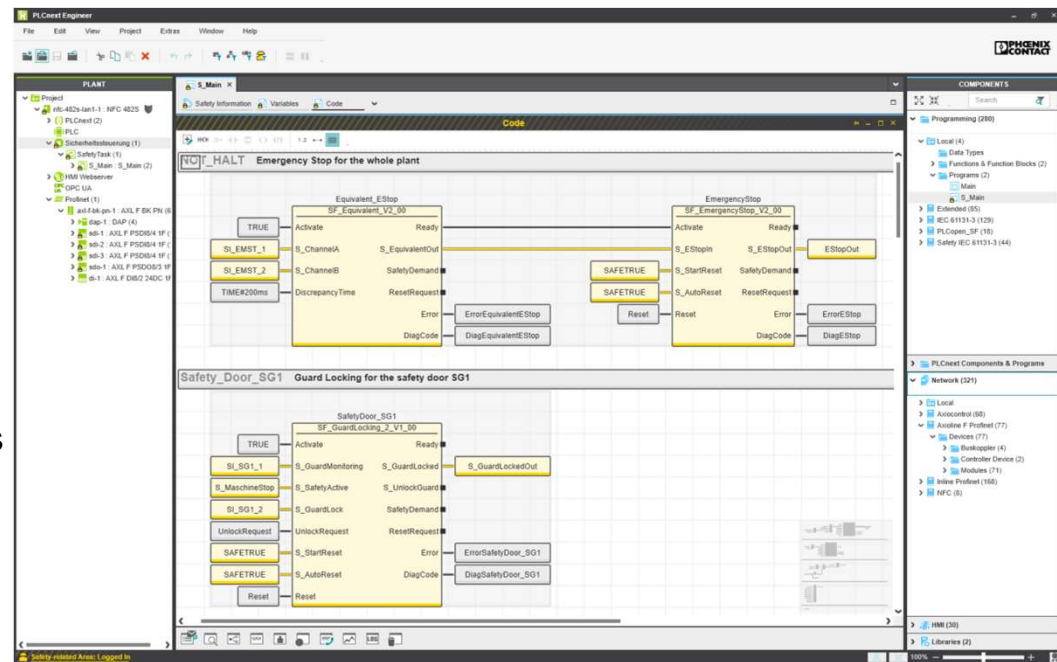

Functional Safety Programming



Fully integrated Safety Programming

- Individual safety functions can be protected by a verification function
- Background signal path analysis
- Background safe semantic analysis
- Diversely-redundant code generator

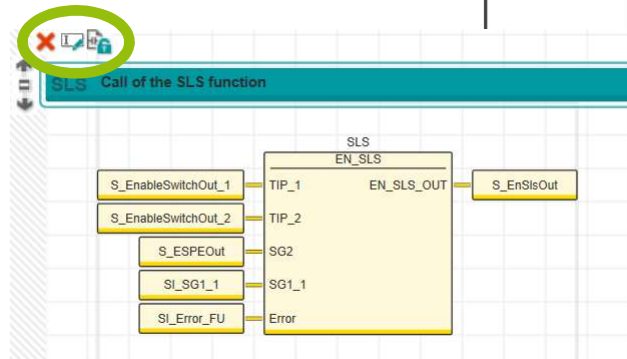
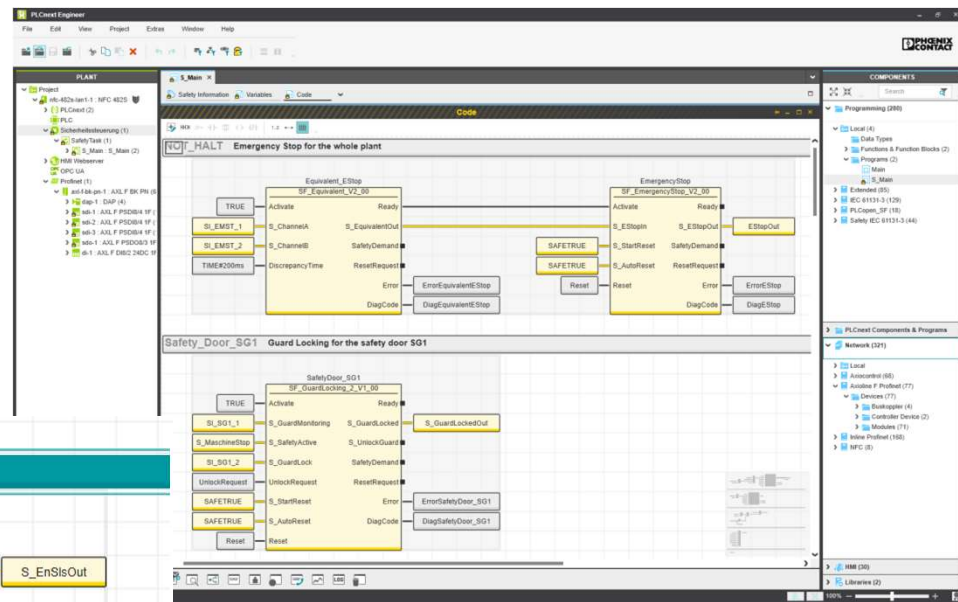

Functional Safety User Libraries



- Export of safety-related function blocks as new user library

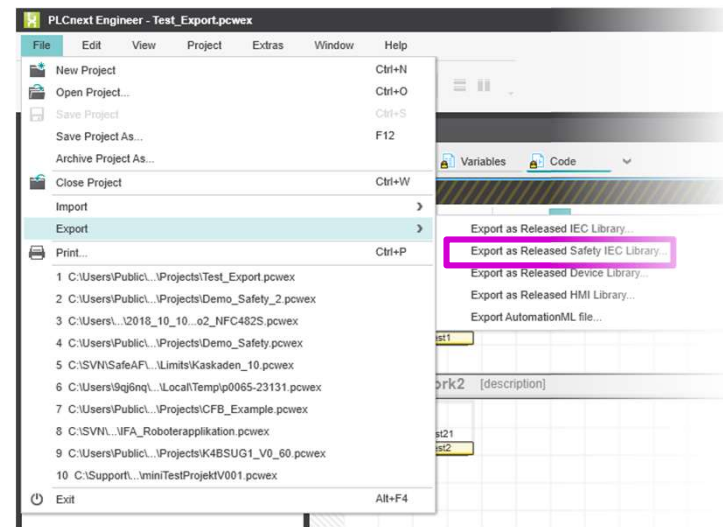
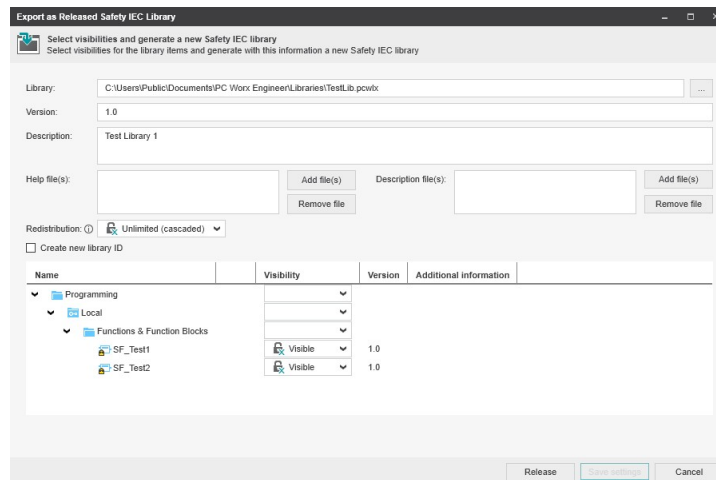

Safety Parameterization



- Parameterization for PROFIsafe devices
- Export / Import
 - Parameter sets of the whole device
 - Parameter sets of a single group

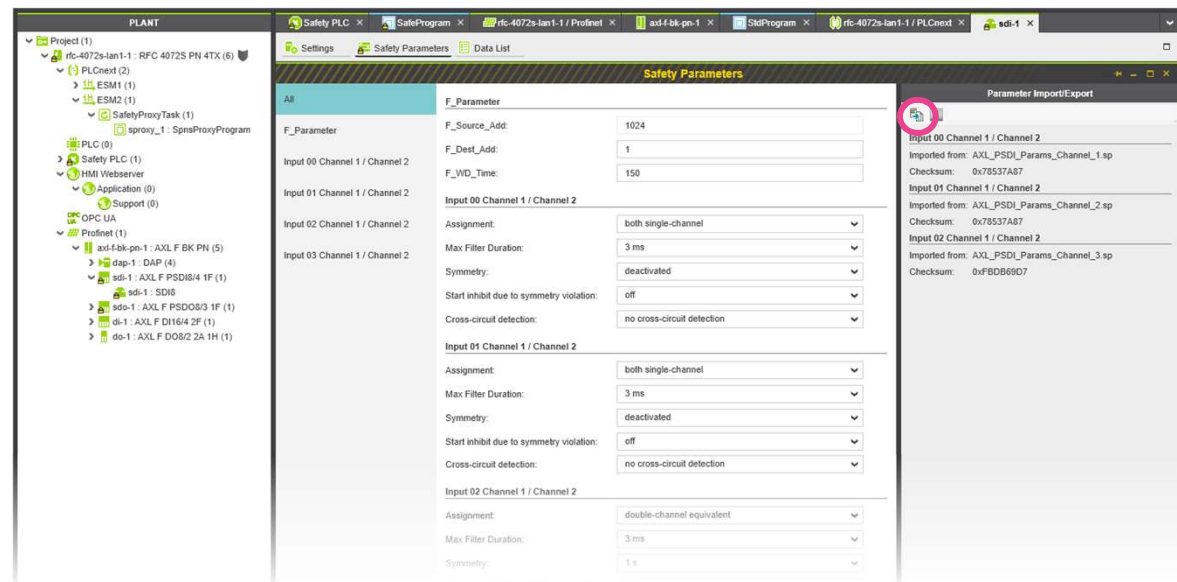

Safety Cockpit



- Display the status information from the safety-related PLC
- Display the error messages from the safety-related PLC

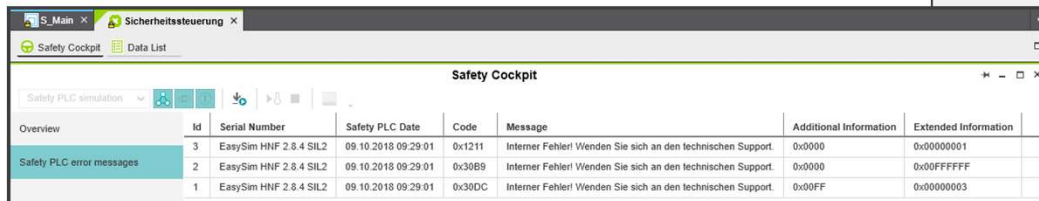

Overview	Id	Serial Number	Safety PLC Date	Code	Message	Additional Information	Extended Information
Safety PLC error messages	3	EasySim HNF 2.8.4 SIL2	09.10.2018 09:29:01	0x1211	Interner Fehler! Wenden Sie sich an den technischen Support.	0x0000	0x00000001
	2	EasySim HNF 2.8.4 SIL2	09.10.2018 09:29:01	0x30B9	Interner Fehler! Wenden Sie sich an den technischen Support.	0x0000	0x00FFFFFF
	1	EasySim HNF 2.8.4 SIL2	09.10.2018 09:29:01	0x30DC	Interner Fehler! Wenden Sie sich an den technischen Support.	0x00FF	0x00000003

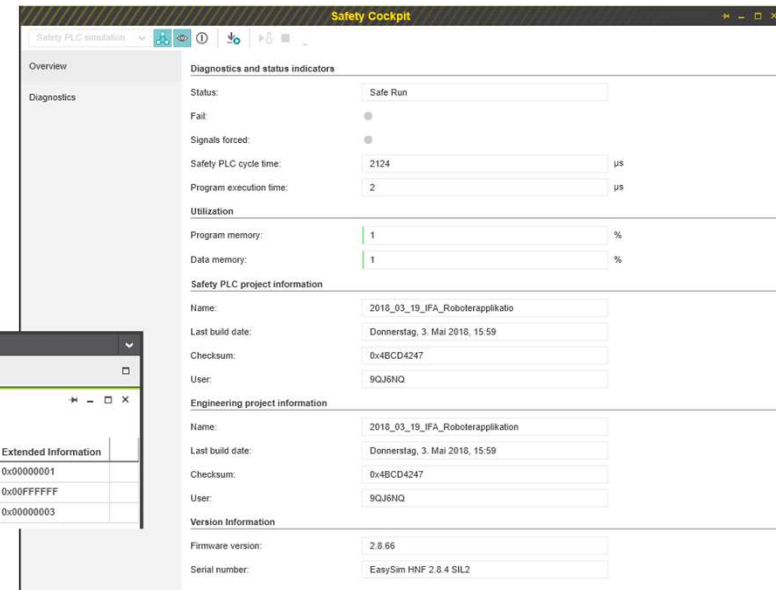

Safety Cockpit

Safety PLC simulation

Overview

Diagnostics and status indicators

Status: Safe Run

Fail:

Signals forced:

Safety PLC cycle time: 2124 µs

Program execution time: 2 µs

Utilization

Program memory: 1 %

Data memory: 1 %

Safety PLC project information

Name: 2018_03_19_IFA_Roboterapplikatio

Last build date: Donnerstag, 3. Mai 2018, 15:59

Checksum: 0x4BCD4247

User: 9QJ8NQ

Engineering project information

Name: 2018_03_19_IFA_Roboterapplikatio

Last build date: Donnerstag, 3. Mai 2018, 15:59

Checksum: 0x4BCD4247

User: 9QJ8NQ

Version Information

Firmware version: 2.8.66

Serial number: EasySim HNF 2.8.4 SIL2

PLCnext Engineer

Viewer for Simulink



- Model export as part of a PLCnext library
- Drill-down into sub-models
- Online-values for In- and Out-Ports

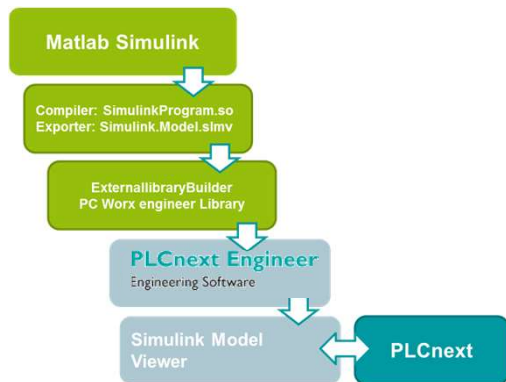

PLCnext Technology 
Designed by PHOENIX CONTACT

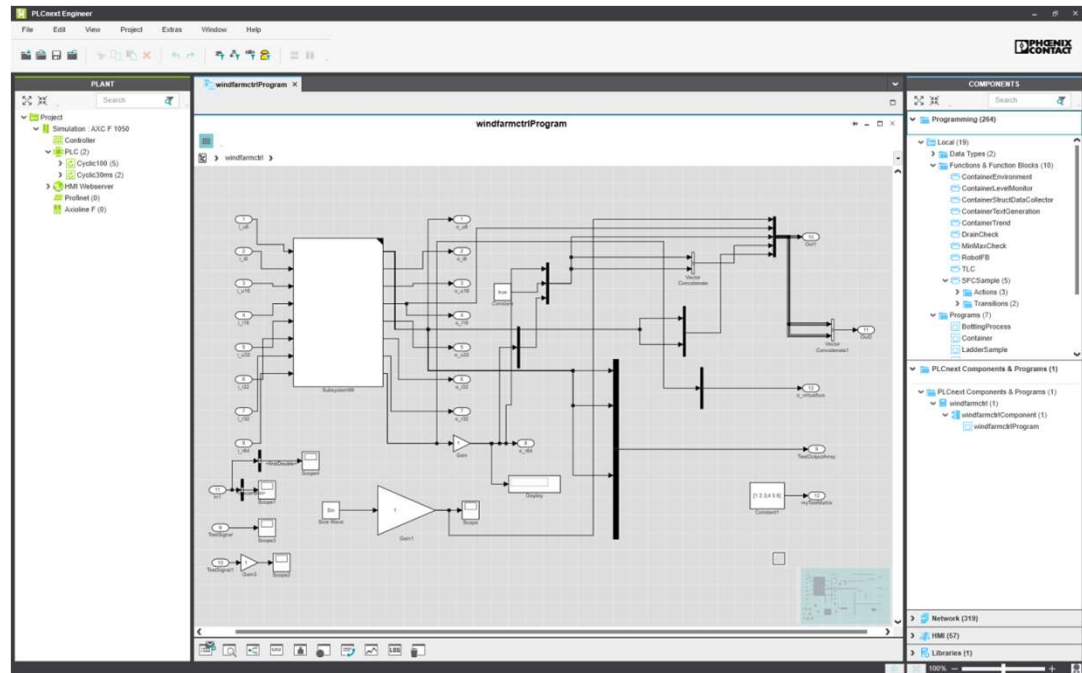

Viewer for Simulink



- Global / Local Search
 - Jumpable objects selected
- Display block with online values
- Overwrite of GDS ports
- Jump to Type Model from Instance
- Online Indication on lines for boolean in /out ports

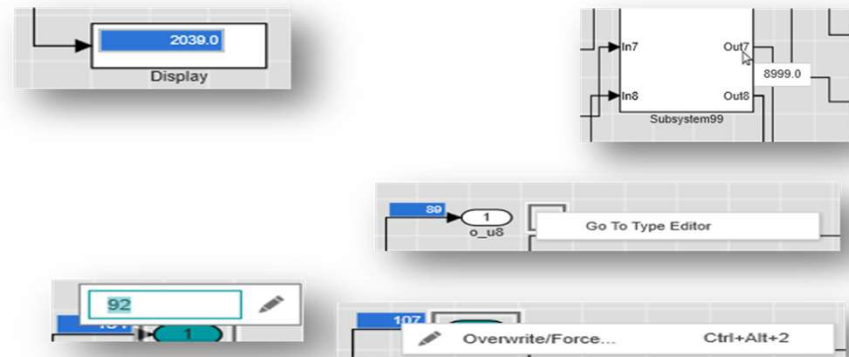
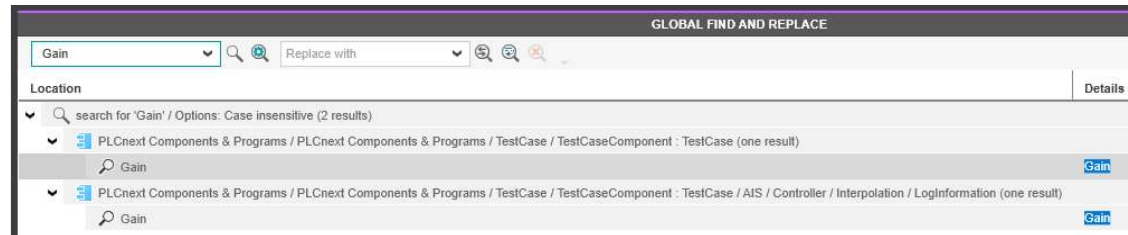

Application Control Interface (ACI)



Remote Control of the software:

- ✓ Application.BuildPath (property)
- ✓ Application.OpenProject (method)
- ✓ Application.ProjectOpened (event)
- ✓ Project.Close (method)
- ✓ Project.Save (method)
- ✓ Project.SaveAs (method)
- ✓ Project.Closed (event)
- ✓

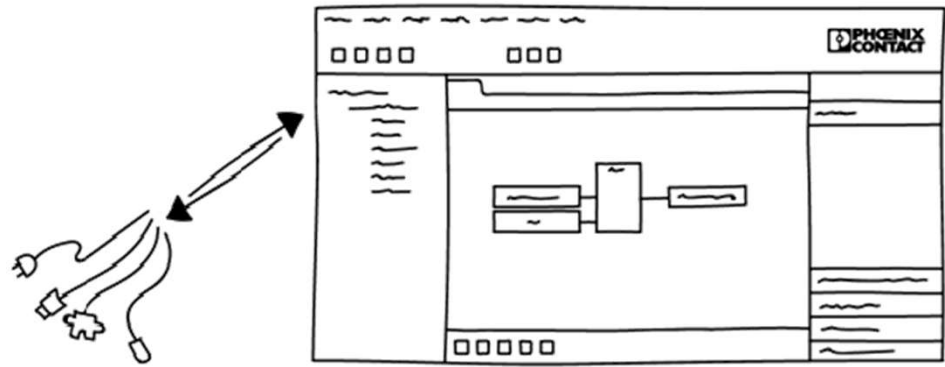

Software License Distribution

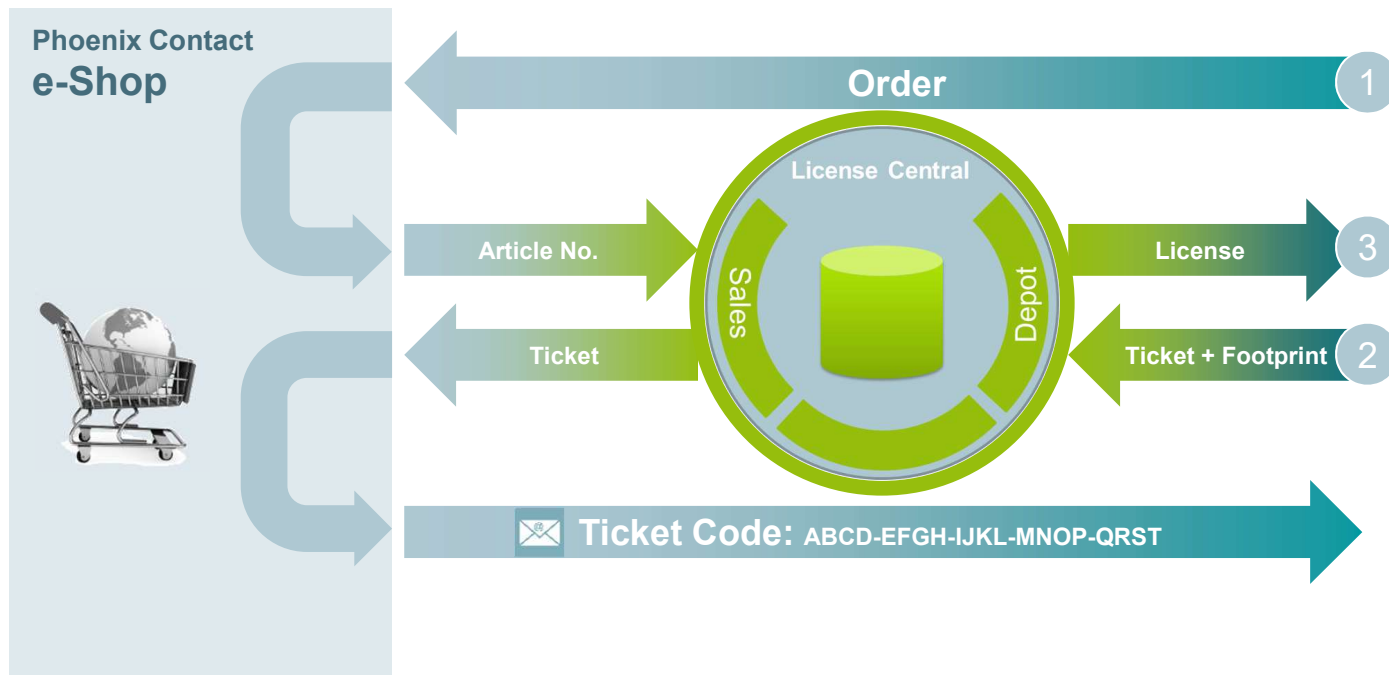

Activation Wizard

- Version 1.1 HMI 2018
 - Deactivating / Moving licenses

- Version 1.2 SPS 2018
 - Network server for licenses
 - Server list; authentication
 - Borrowing of licenses (can be returned to pool)

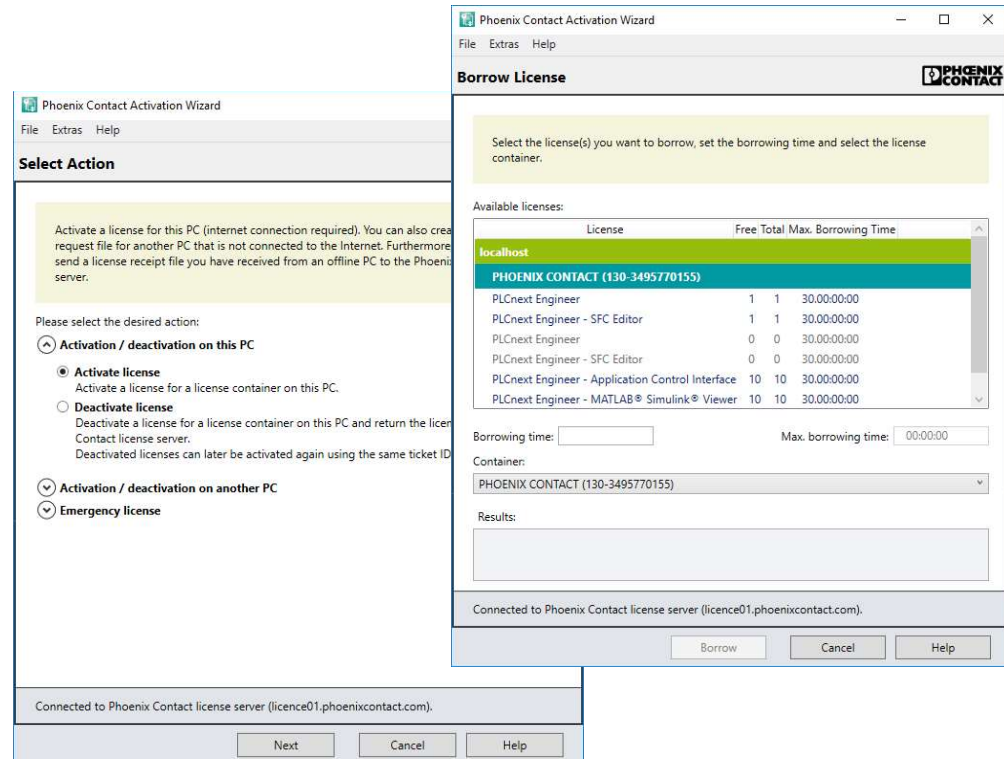

PLCnext Engineer

Electronic Software License on USB A

PLCnext Technology 
Designed by PHOENIX CONTACT

Software dongle - ESL STICK USB A - 1080084



CmDongle for saving licenses for various software products

[Generate product PDF](#)

 current article

[Add to product comparison](#) [Add to part list](#) [Add to shopping cart](#)

Overview | [Technical data](#) | [Downloads](#)

Product Description

Up to 2000 licenses with different license models for various software tools can be stored on the license dongle. Licenses can be used flexibly by moving the dongle from one computer to another.

Use of a license dongle is recommended when using virtual machines. This means that licenses can still be used after virtual machines are copied or even if settings are changed on the virtual machine.

Using the "Activation Wizard" software tool, activate and deactivate licenses on the license dongle. Or use the "Activation Wizard" to migrate licenses from a PC hard drive to a license dongle (or vice versa), for example.

No additional drivers are required to operate the dongle. After it is connected to a computer, it can immediately be used without administrator rights.



45



IF Design Award 2019



Automation Modules

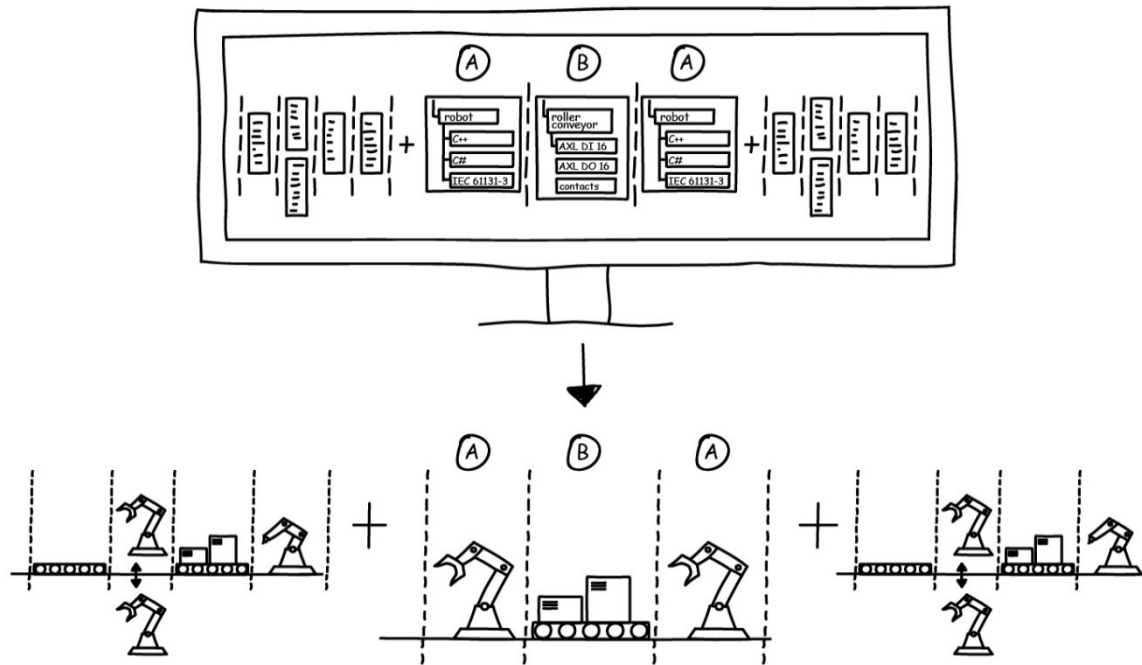

Automation Modules

- **Reusability across all trades**
 - Can contain all items from the application
 - IEC 61131-3 Code
 - Visualization pages
 - Data connections
 - Hardware configuration
 - High language programs
 - Safety function

Orchestrate instead of programming!

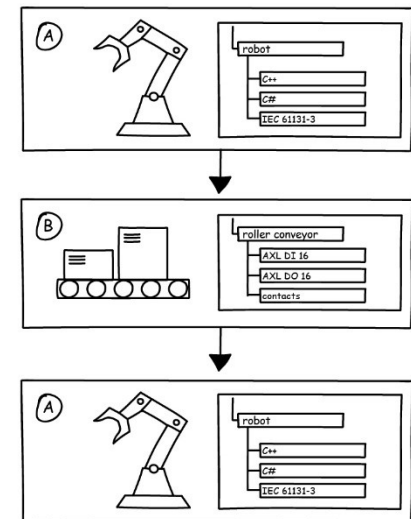
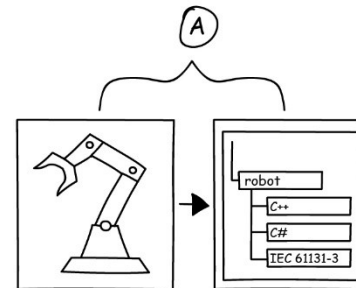

PLCnext Engineer 2019.3

AutomationML APC Interface

Automation Project Configuration

- Reuse identifier (devices, terminal points)
- Create prewired variables
- Import / Export / Synchronization

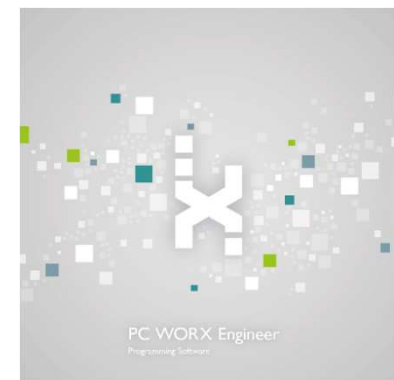
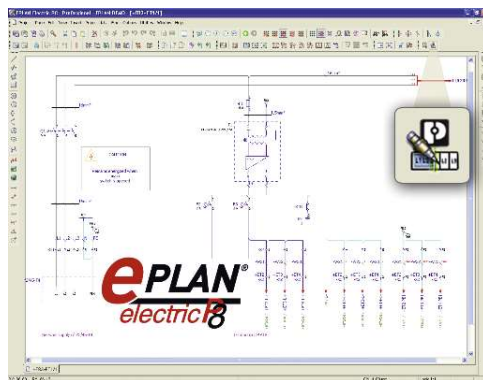
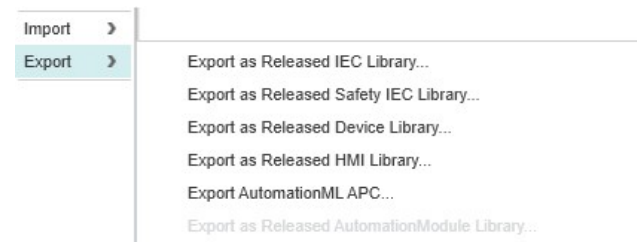

PLCnext Engineer Versioning

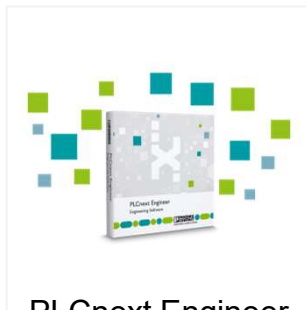

PLCnext Engineer
2020.0 LTS

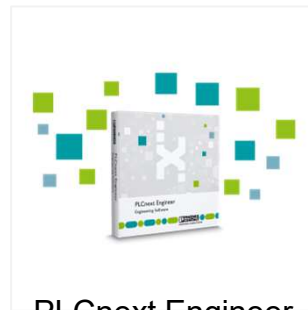

PLCnext Engineer
2020.3

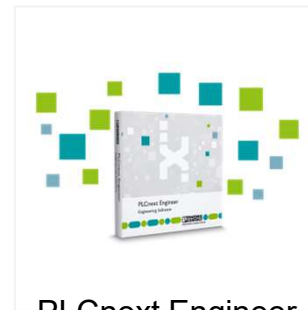

PLCnext Engineer
2020.6

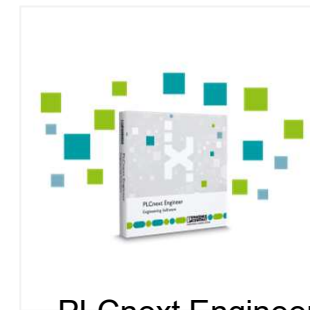

PLCnext Engineer
2020.9



January
2020

March
2020

June
2020

September
2020

PLCnext Engineer

LTS Version

Wikipedia:

Long-term support (LTS) ...

... is a product lifecycle management policy in which a stable release of computer software is maintained for a longer period of time than the standard edition. The term is typically reserved for open-source software, where it describes a software edition that is supported for months or years longer than the software's standard edition.

Source 2019/01: https://en.wikipedia.org/wiki/Long-term_support



Feature-Driven Development

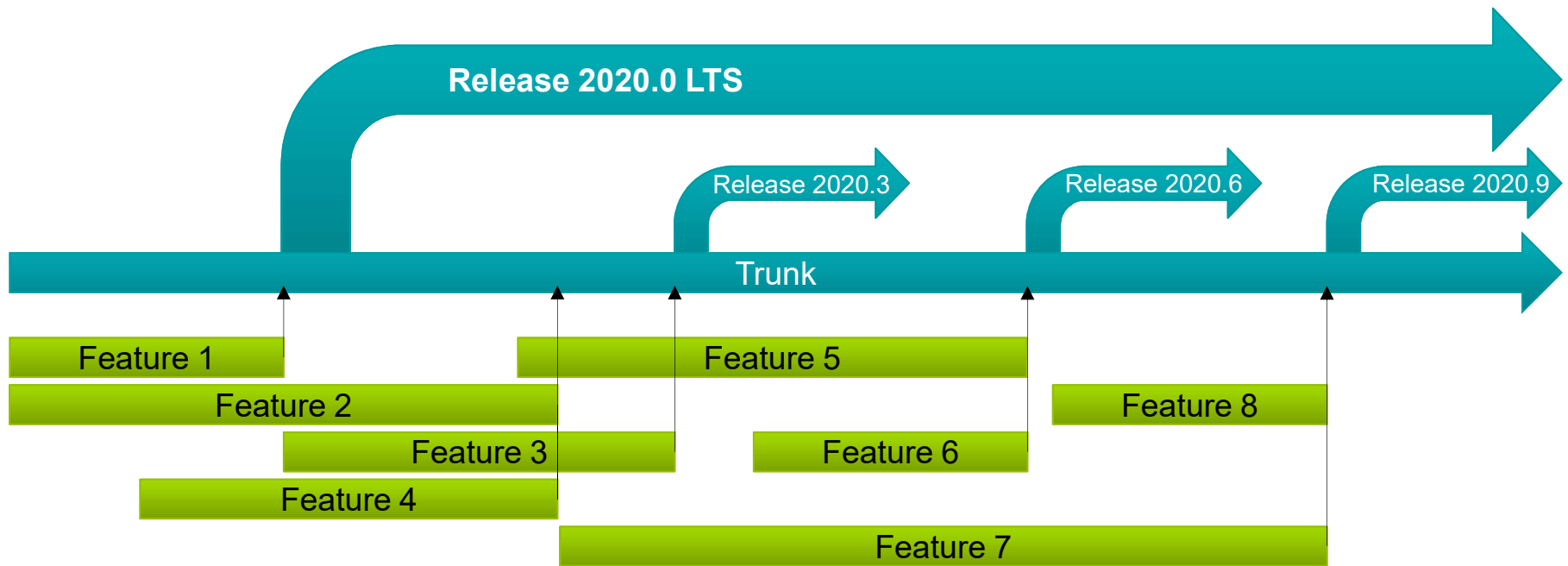

PLCnext Engineer

PLCnext Engineer 2020

PLCnext Technology 
Designed by PHOENIX CONTACT



Thank you



Video Youtube

PLCnext Engineer Tutorial(s)

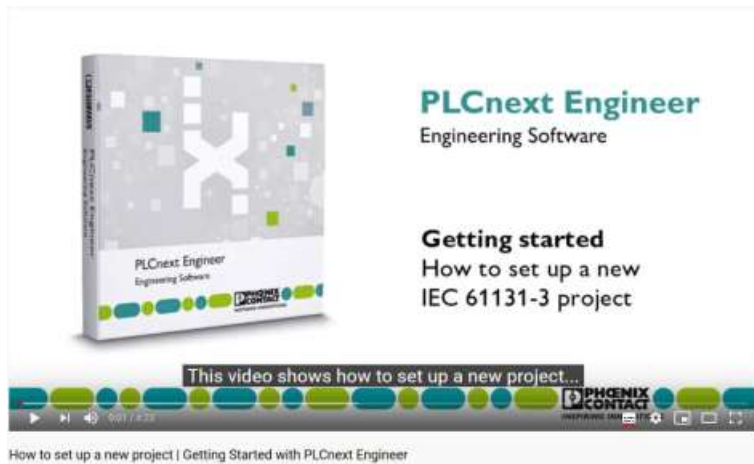

Video Youtube

PLCnext Engineer Tutorial(s)

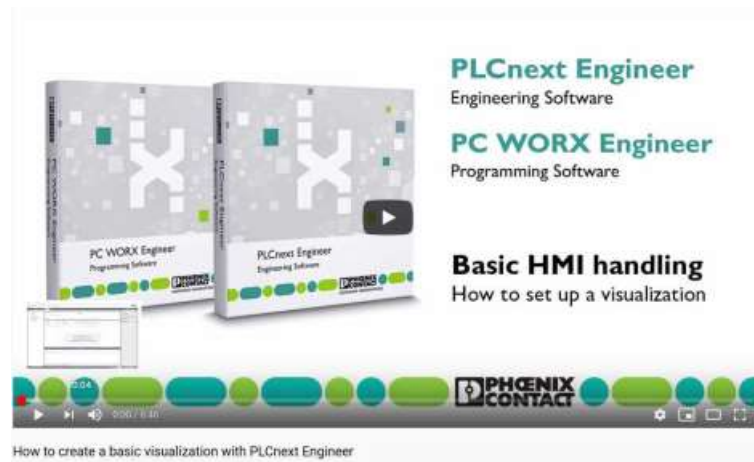

Video Youtube

PLCnext Engineer Tutorial(s)



Video Youtube

PLCnext Engineer Tutorial(s)



Video Youtube

PLCnext Engineer Tutorial(s)



Video Youtube

PLCnext Engineer Tutorial(s)



Video Youtube

PLCnext Engineer Tutorial(s)



[1] PLCnext Engineer | Comenzando con PLCNext - Phoenix Contact

Video Youtube

PLCnext Engineer Tutorial(s)

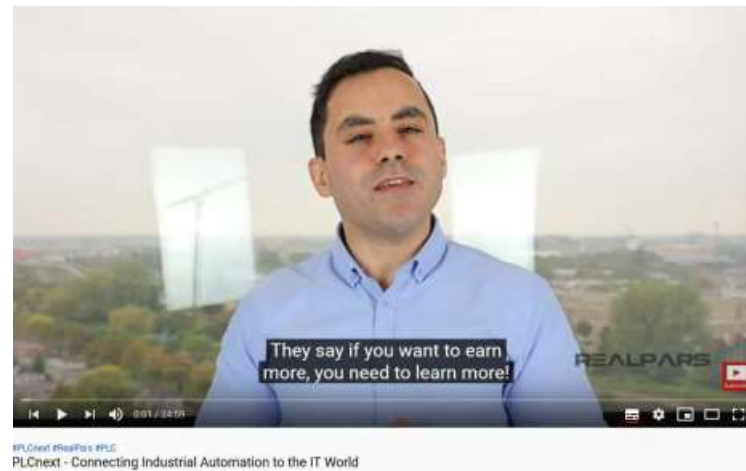

Video Youtube

PLCnext Engineer Tutorial(s)

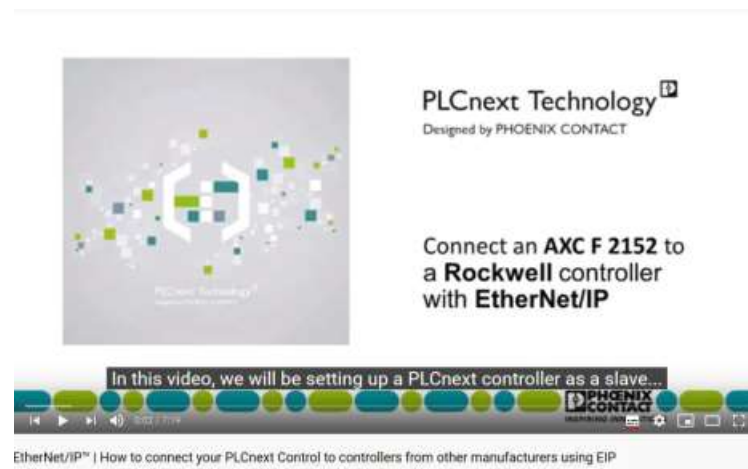

Video Youtube

PLCnext Engineer Tutorial(s)



Video Youtube

PLCnext Engineer Tutorial(s)



PLCnext Technology | DataLogger in IIoT | Configure the DataLogger for "Record on Time" mode



PLCnext Technology | DataLogger in IIoT | Configure the DataLogger for "Record on change" mode

Video Youtube

PLCnext Engineer Tutorial(s)

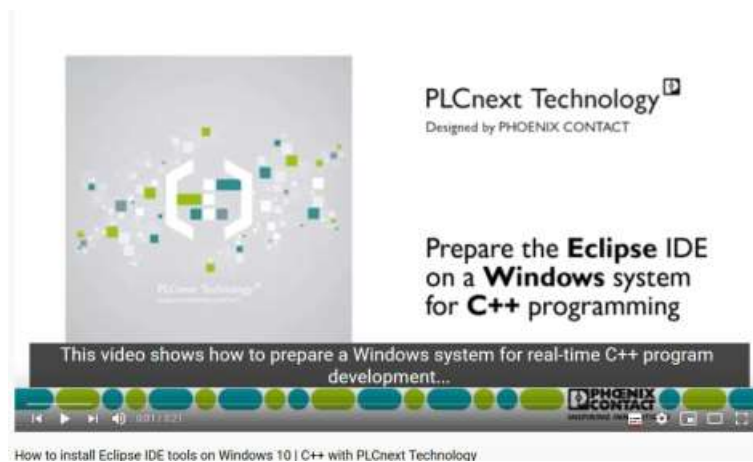

Video Youtube

PLCnext Engineer Tutorial(s)



Video Youtube

PLCnext Engineer Tutorial(s)



Video Youtube

PLCnext Engineer Tutorial(s)

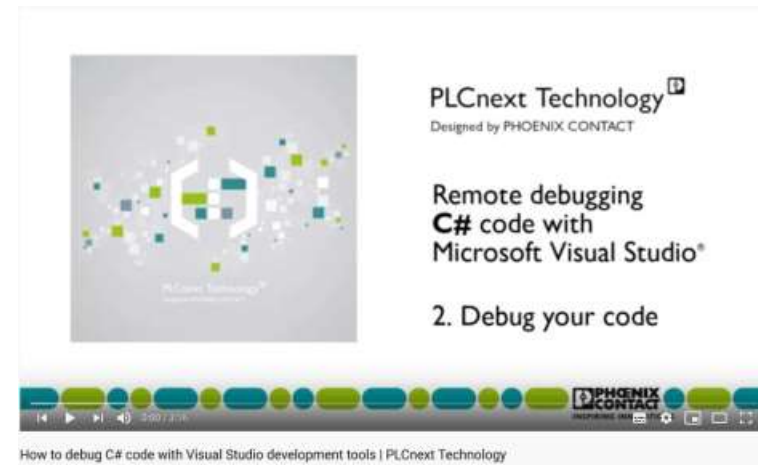
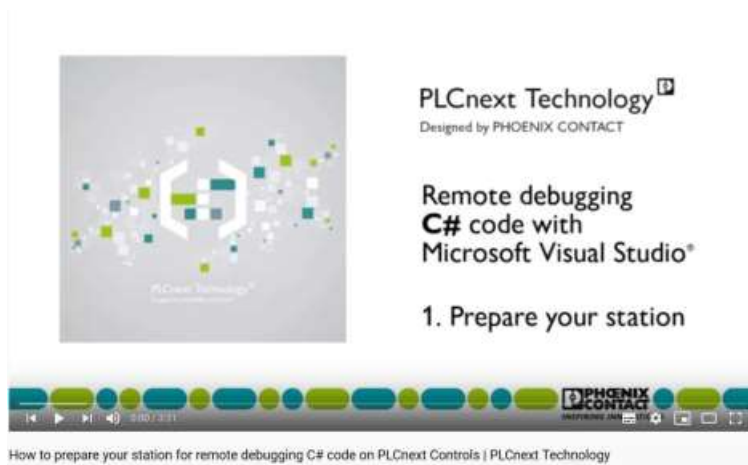

Video Youtube

PLCnext Engineer Tutorial(s)



PC WORX
Target for
Simulink

PC WORX
PLC Programming

PHOENIX CONTACT

PLCnext TechnologyTM
Designed by PHOENIX CONTACT

How to prepare
a **Simulink®** model
for a specific PLC



PHOENIX CONTACT

How to prepare a Simulink model for PLC programming | #1 Simulink with PLCnext Technology

Video Youtube

PLCnext Engineer Tutorial(s)

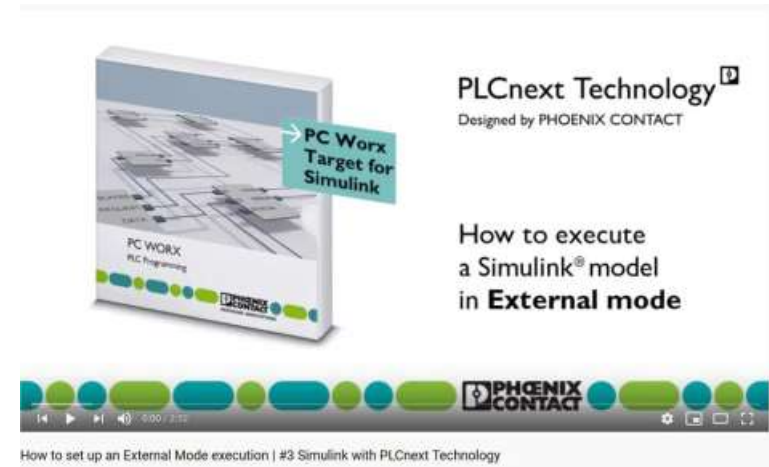
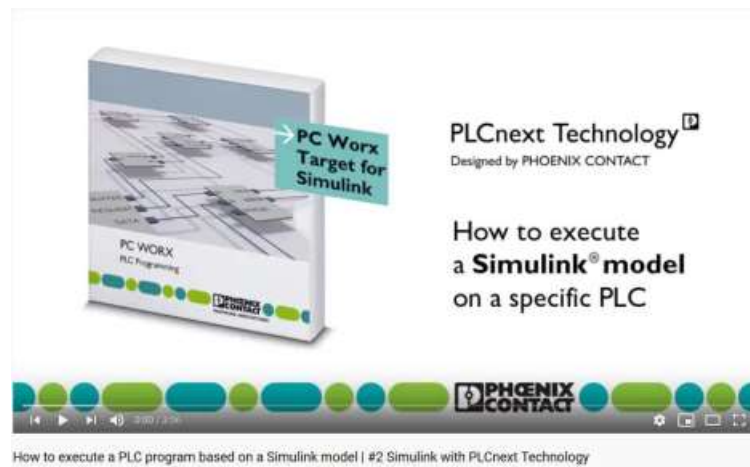

Video Youtube

PLCnext Engineer Tutorial(s)

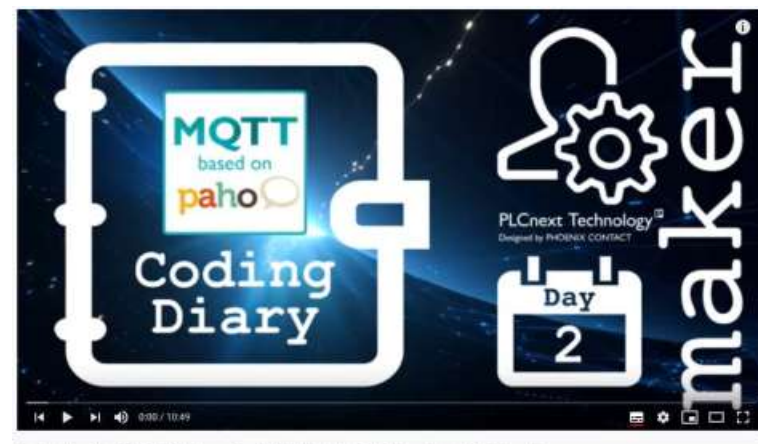

Video Youtube

PLCnext Engineer Tutorial(s)

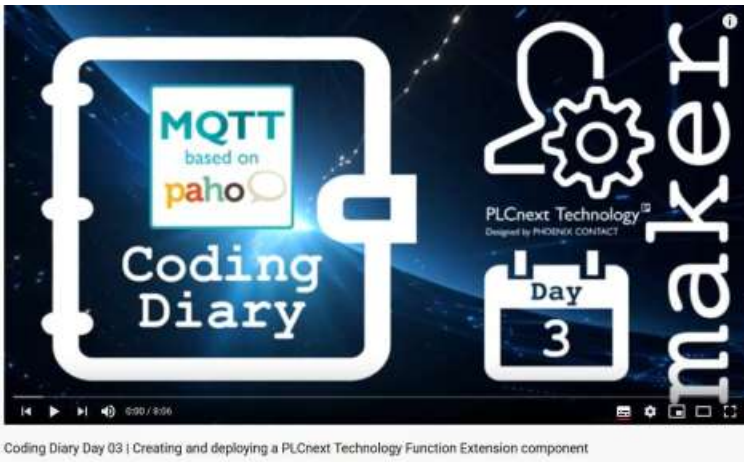

Video Youtube

PLCnext Engineer Tutorial(s)

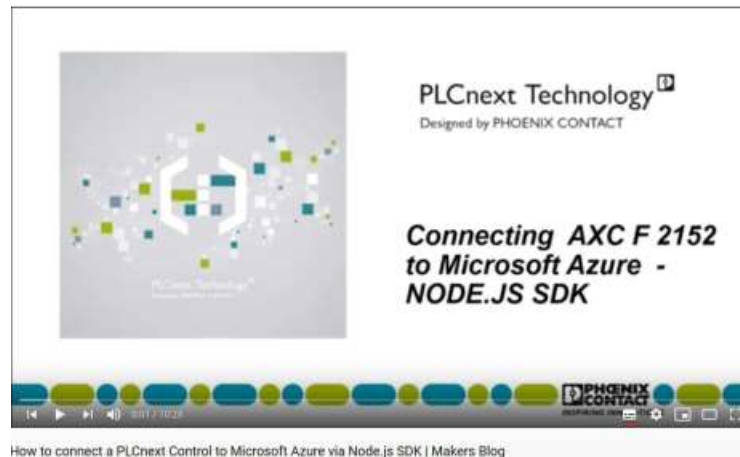

Video Youtube

PLCnext Engineer Tutorial(s)



Video Youtube

PLCnext Engineer Tutorial(s)



Video Youtube

PLCnext Engineer Tutorial(s)



Video Youtube

PLCnext Engineer Tutorial(s)

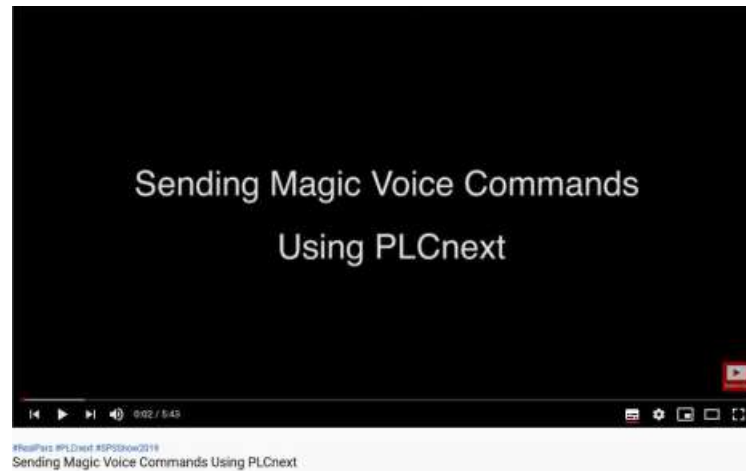

Antonio Gordillo / Marketing IMA / agordillo@phoenixcontact.com.mx

PLCnext Engineer

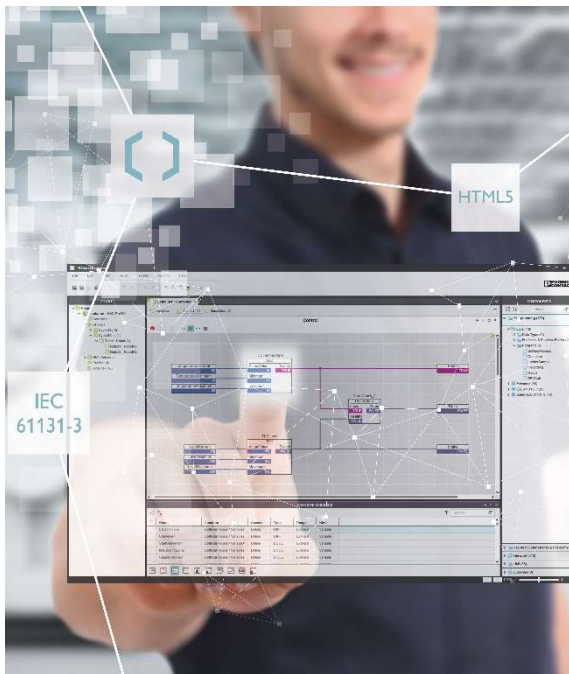

Thank you